

P1

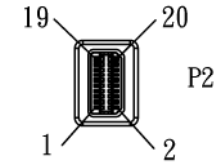
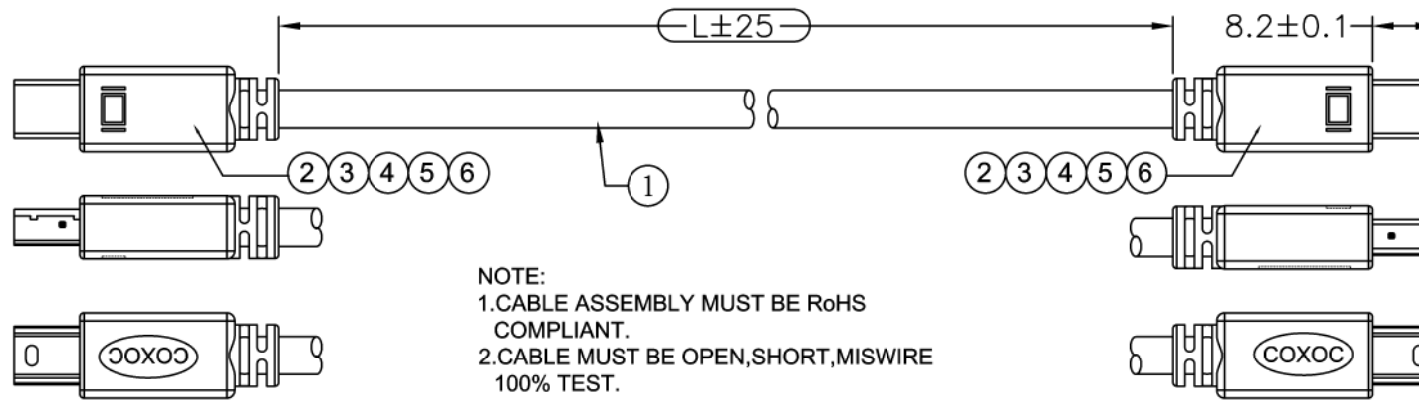
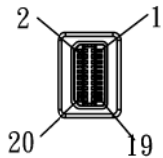

MiniDP 20M

NOTE:
 1. CABLE ASSEMBLY MUST BE RoHS COMPLIANT.
 2. CABLE MUST BE OPEN, SHORT, MISWIRE 100% TEST.
 3. ELECTRIC TEST:
 A. VOLTAGE: 300V DC.
 B. CONTACT RESISTANCE: 5 Ohm Max.
 C. INSULATION RESISTANCE: 2M Ohm Min.

PART NO.

SERIES NO. CK 03 1 3 B06 E XXX LENGTH NO.
 CK=Displayport 475=475±25mm
 CONNECTOR OPTION 60C=600±25mm
 03=MINIDP/MINIDP-20 GREEN OPTION:
 (MOLDED/MOLDED) E=RoHS
 CONNECTOR TYPE XXX TYPE.
 1=M/M
 CABLE COLOR 3=BLACK

Pin Assignment

P1	WHITE	P2	P1	WHITE	P2
3	BROWN	12	16	BLACK	16
5	DRAIN	10	18	DRAIN	18
1	WHITE	8	14	YELLOW	14
9	RED	17	2	RED	2
11	DRAIN	15	4	ORANGE	4
7	WHITE	13	6	WHITE	6
15	GREEN	11	19	BRAID	19
17	DRAIN	9	SHELL	SHELL	
13	WHITE	7			
10	BLUE	5			
12	DRAIN	3			
8		1			

For SIP

6	PVC	PVC 60P BLACK
5	FOIL	COPPER FOIL
4	PE	PE
3	Tin	Tin Stick, Tin OD:0.8mm
2	CONN	MINI DP 20P Male, Black Insulator, Contact Gold Plated 15u", Shell Nickel Plated
1	CABLE	UL20276 (1P#32+D+AL+MYLAR)*5C+4C#32+MYLAR+AB OD:5.0mm PVC JACKET COLOR BLACK

UNLESS OTHERWISE SPECIFIED TOLERANCE		
0. ±1.0		
.0 ±0.5		CHANT SINCERE CO., LTD TEL:886-02-86471251 FAX:886-02-86472962
.00 ±0.3		
SCALE: AS SHOWN	UNIT: mm	DRAWN NAME: Mini DP TO Mini DP 20M CABLE
DRAWN		PRODUCT NO. CK0313B06EXXX
CHECKED		FILE NAME: CK0313B06E(GB)
APPROVED		

REV.	DESCRIPTION	DATE

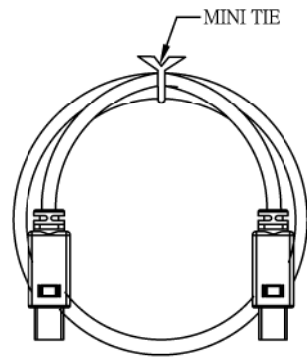

USB C/AM 3.1 CABLE

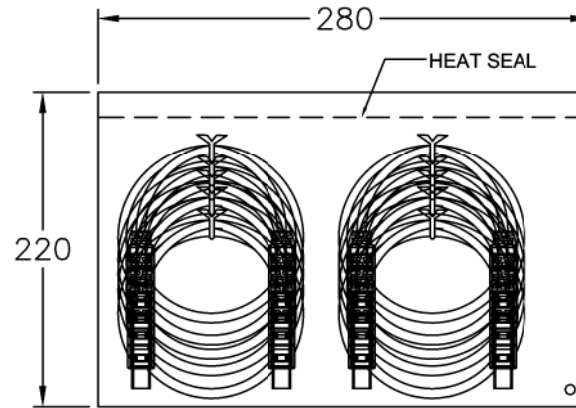

PE BAG:L280*W220*T0.05mm
10PCS CABLE/PE BAG

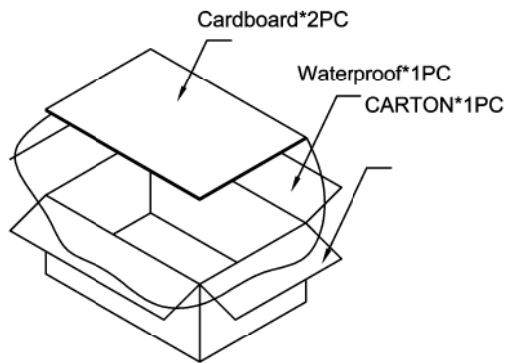

(CARTON:L457*W298*H228mm Material K=K)

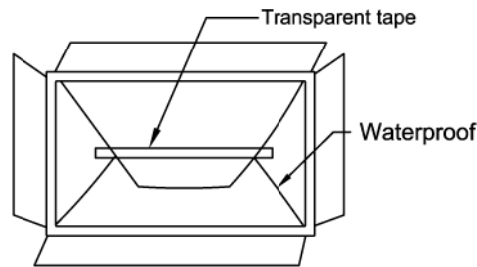

(After the installed Product,
carton sealing tape should be transparent)

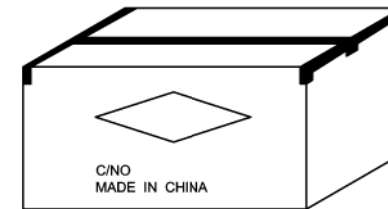

(CARTON:L457*W298*H228mm,Material K=K)
(200PCS CABLE/CARTON)

PO NO:	
ITEM NO:	
QTY:	PCS
N.W.:	KGS
G.W.:	KGS
MEAS:	1.1'

(CARTON SIDE)

For SIP
For CmK/Cpk

UNLESS OTHERWISE SPECIFIED TOLERANCE	
ANG.	±
0.	±1
.0	±0.5
.00	±0.25

CHANT SINCERE CO.,LTD
 TEL:886-02-86471251 FAX:886-02-86472962

SCALE: AS SHOWN UNIT: mm

DRAWN
 CHECKED
 APPROVED

DRAWN NAME:
 Mini DP TO Mini DP 20M CABLE
 PRODUCT NO.: CK0313B06EXXX

REV.	DESCRIPTION	DATE	SIZE	A4	REV.	B	FILE NAME:
------	-------------	------	------	----	------	---	------------

2/2

FILE NAME: CK0313B06E(GB)