

HF compliant



**SPECIFICATION**

**MATERIAL AND FINISH:**

- 1. CAGE: COPPER ALLOY
- 2. CONNECTOR:
  - PLASTIC HOUSING: HIGH TEMPERATURE LCP, UL94 V-0
  - LIGHT PIPE: POLYCARBONATE; COLOR: CLEAR
  - SPRING: STAINLESS STEEL
  - CONTACTS: PHOSPHOR BRONZE
  - CONTACT PLATING: 15u" MIN. GOLD ON MATING AREA, 150u" MATTE SN ON SOLDER TAILS

**TEMPERATURE RANGE:**

- 1. OPERATING : -40°C TO +85°C
- 2. NON OPERATING : -55C TO +105°C

**PACKING STYLE:**

- 1. TRAY PACKAGING

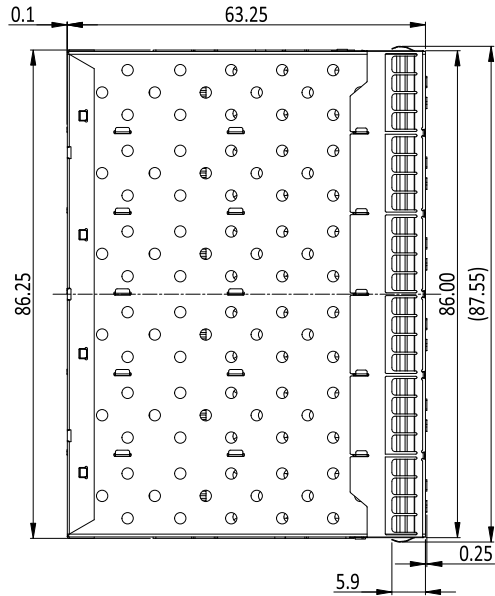

THE LEFT AND RIGHT SIDE REED SHAPES AND DIMENSIONS ARE THE SAME AS THE REED

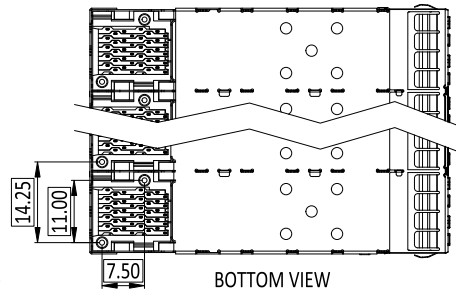

BOTTOM VIEW

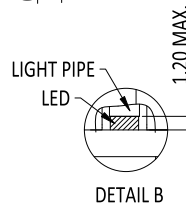
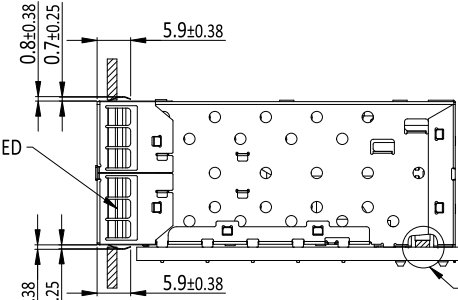

DETAIL B

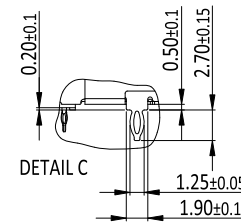

DETAIL C

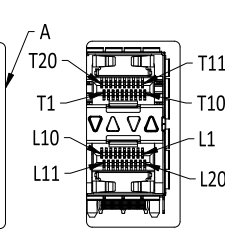
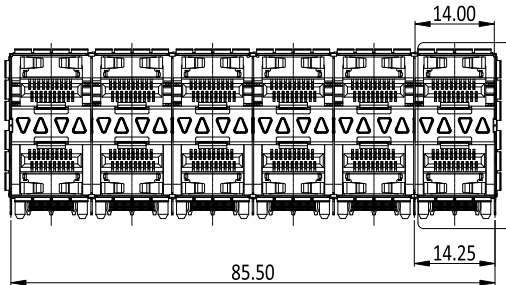
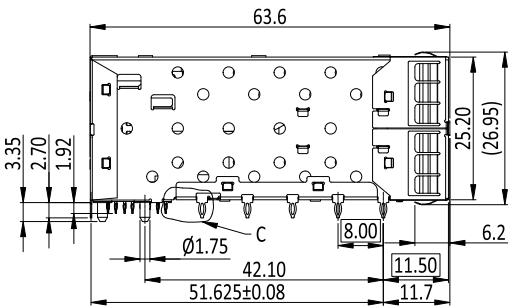

DETAIL A

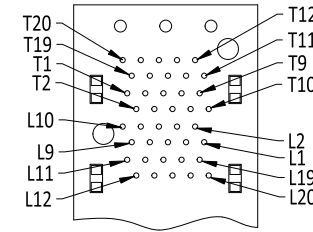

CONNECTOR PIN-OUT COMPONENT SIDE OF BOARD

2					
1	59127090010	902GHB6BCTA201A3	NON PLATING/SPRING		
ITEM	NEW P/N	OLD P/N	SHELL PLATING/TYPE	NOTE	
UNLESS OTHERWISE SPECIFIED TOLERANCE			SIP Cmk Cpk	 <b>CHANT SINCERE CO.,LTD</b>	
.X	±0.20	.X			±1°
.XX	±0.15	.XX			±5°
.XXX	±0.10				
SCALE:	AS SHOWN		UNIT:	mm	
DRAWN:	KEVIN_ZHENG		DATE:	11 Jan 2024	
CHECKED:	PEARL_HUNG		DATE:	26 Feb 2024	
APPROVED:	PEARL_HUNG		DATE:	26 Feb 2024	
			PART NO.	59127090010	
ZONE	REVISION	DESCRIPTION	DATE	REV. A	
1	2	3	4	5	
			SIZE	A4	
			SHEET	1/4	
			REV.	A	
			CODE:	X07	
			CUSTOMER:		
1	2	3	4	5	
			REV.	A	
			CODE:	X07	
			CUSTOMER:		
1	2	3	4	5	

TITLE: PDR- SFP+ 2x6 CAGE AND CONNECTOR ASSEMBLY, PRESS FIT, WITH EMI SPRINGS



HF  
compliant

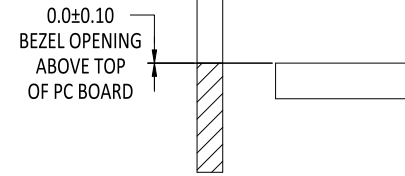
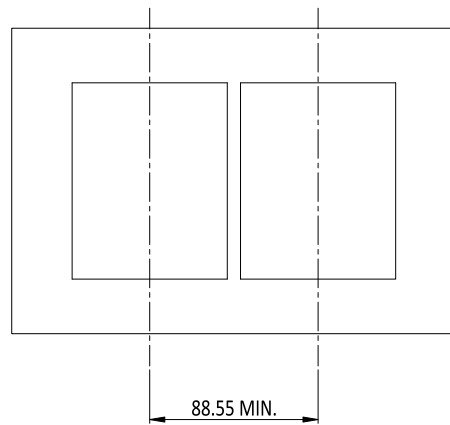
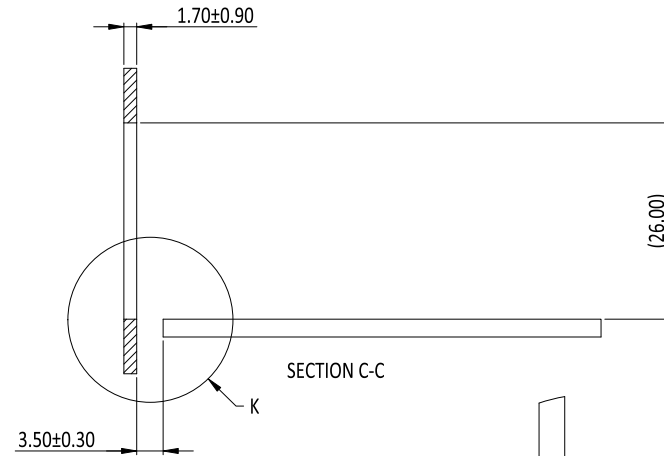
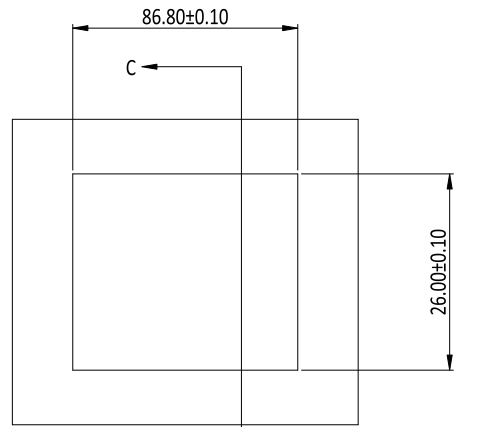

RECOMMENDED BEZEL DESIGN

DETAIL K

UNLESS OTHERWISE SPECIFIED TOLERANCE		SIP		 <b>CHANT SINCERE CO., LTD</b>	
.X ±0.20	.X ±1°	Cmk Cpk			
.XX ±0.15	.XX ±5°				
.XXX ±0.10		SCALE: AS SHOWN	UNIT: mm		
		DRAWN: KEVIN_ZHENG	11 Jan 2024	TITLE: PDR- SFP+ 2x6 CAGE AND CONNECTOR ASSEMBLY, PRESS FIT, WITH EMI SPRINGS	
		CHECKED: PEARL_HUNG	26 Feb 2024		
		APPROVED: PEARL_HUNG	26 Feb 2024		
				PART NO. 59127090010	
ZONE	REVISION	DESCRIPTION	DATE	CODE: X07	CUSTOMER:
1	2	3	4	5	6

1	2	3	4	5	6	7	8	9	10
G	F	E	D	C	B	A			

RoHS  
compliant



PACKAGE INFORMATION AND LABEL

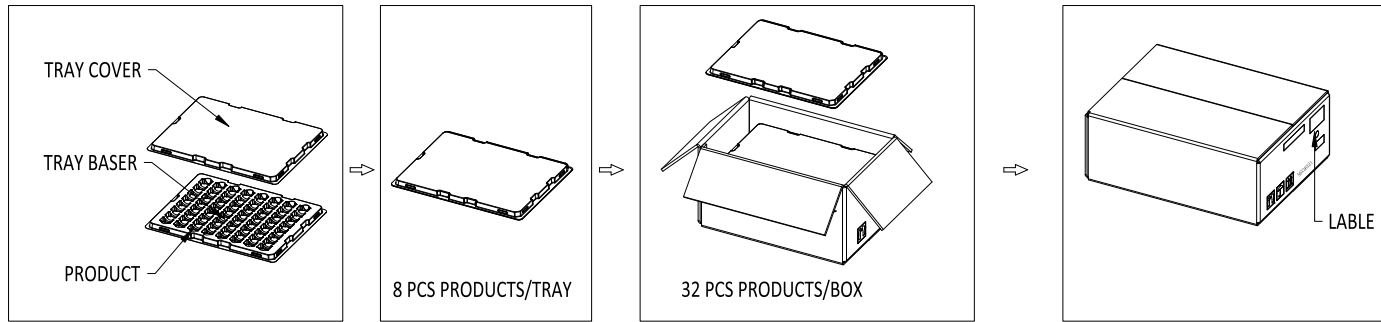

PACKING QUANTITY : 8 PCS FINISHED GOODS PER TRAY  
4 TRAYS (32 PCS FINISHED GOODS) PER CARTON BOX

UNLESS OTHERWISE SPECIFIED TOLERANCE		SIP		 <b>CHANT SINCERE CO.,LTD</b>	
.X ±0.20	.X ±1°	Cmk Cpk			
.XX ±0.15	.XX ±5°				
.XXX ±0.10		SCALE: AS SHOWN	UNIT: mm		
		DRAWN: KEVIN_ZHENG	11 Jan 2024	TITLE: PDR- SFP+ 2x6 CAGE AND CONNECTOR ASSEMBLY, PRESS FIT, WITH EMI SPRINGS	
		CHECKED: PEARL_HUNG	26 Feb 2024		
		APPROVED: PEARL_HUNG	26 Feb 2024	PART NO. 59127090010	
ZONE	REVISION	DESCRIPTION	DATE	CODE: X07	CUSTOMER:

1	2	3	4	5	6	7	8	9	10
G									
F									
E									
D									
C									
B									
A									
1	2	3	4	5	6	7	8	9	10