

RoHS compliant



**ELECTRICAL CHARACTERISTIC:**  
 1. CURRENT: 5A MIN FOR VBUS; 0.25A MIN. FOR OTHER  
 2. VOLTAGE: 5VAC MAX.  
 3. WITHSTANDING VOLTAGE: 100V AC  
 4. CONTACT RESISTANCE: 40mΩ MAX.  
 5. INSULATION RESISTANCE: 100MΩ MIN.

**MECHANICAL CHARACTERISTIC:**  
 1. INSERTION: 5~20N.  
 2. EXTRACTION: 8~20N.  
 3. DURABILITY: 10000 CYCLES

**ENVIRONMENTAL:**  
 1. OPERATING TEMPERATURE RANGE: -55°C TO +85°C

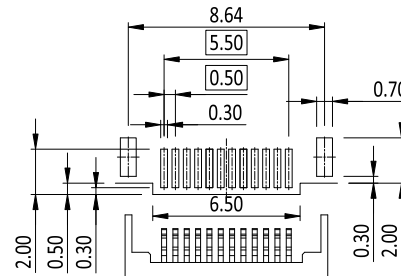
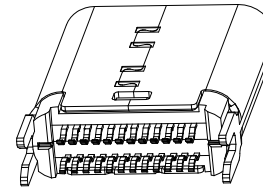
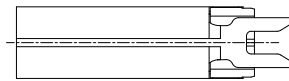
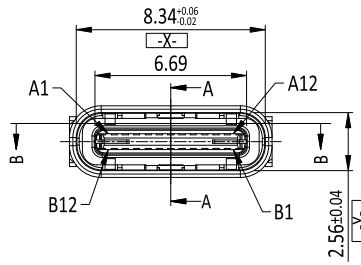
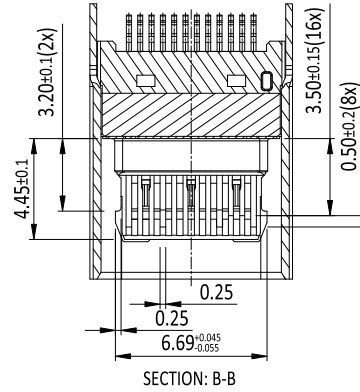
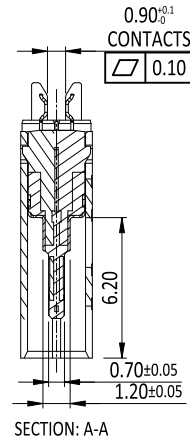
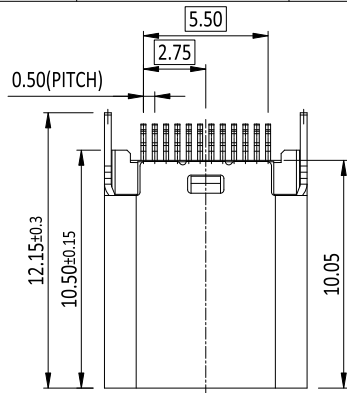

RECOMMENDED PCB LAYOUT (T: 1.00mm)  
TOLERANCE UNSPECIFIED ±0.05mm

5	GROUND	SUS304	CLEAN	1
4	MID-PLATE	SUS301	CLEAN	1
3	SHELL	SUS304	NI PLATED	1
2	TERMINAL	C7025	G/F OR AU 30u"/NI PLATED	24
1	HOUSING	LCP BLACK	(UL94V-0)	1
NO.	PART NAME	MATERIAL	DESCRIPTION	Q'TY

3	53316010030	N/A	GOLD FLASH /NI PLATED	TRAY	
2	53316010020	N/A	AU 30u"/NI PLATED	TRAY	
1	53316010010	317CD24BSTFBN1A3	GOLD FLASH/SN MATTE	TRAY	EOL
ITEM	NEW P/N	OLD P/N	TERMINAL	PACKING STYLE	NOTE

UNLESS OTHERWISE SPECIFIED TOLERANCE  
 3 PLACE ± 0.15  
 2 PLACE ± 0.25  
 1 PLACE ± 0.35  
 0 PLACE ± 0.50  
 ANGULAR ± 3°

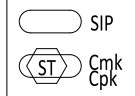

B3,B6		D	ECN-2503065(TINA)ADD P/N & MODIFY BOM	17MAR2025	DRAWN: XINGRU_LAI	18 Mar 2025	TITLE: PDR-	
		C	ECN-2403004(王林曉)CHANGE OUTLINE	01MAR2024	CHECKED: PEARL_HUNG	18 Mar 2025	USB TYPE C FEMALE H10.50 夾板1.0	
		B	ECN-2312073(JOLIN)NEW P/N	25DEC2023	APPROVED: PEARL_HUNG	18 Mar 2025	PART NO. 5331601XXXX	
ZONE	REVISION	DESCRIPTION		DATE	SIZE A4	SHEET 1/1	REV. D	
1	2	3	4	5	6	7	8	
							CODE: B09	CUSTOMER:
							9	10