

NOTE:

1. THE CABLE ASSEMBLY SHOULD BE RoSH2.0 COMPLIANT.
2. THE CABLE ASSEMBLY SHALL MEET BELOW IMPEDANCE REQUIREMENT:
TERMINATION AREA: 85±15% OHMS, CABLE ABSOLUTE: 85±10% OHMS
3. ELECTRICAL AND MECHANICAL PERFORMANCE SHOULD MEET THE PCIe GEN4 INDUSTRIAL STANDARD.

235+20/-0

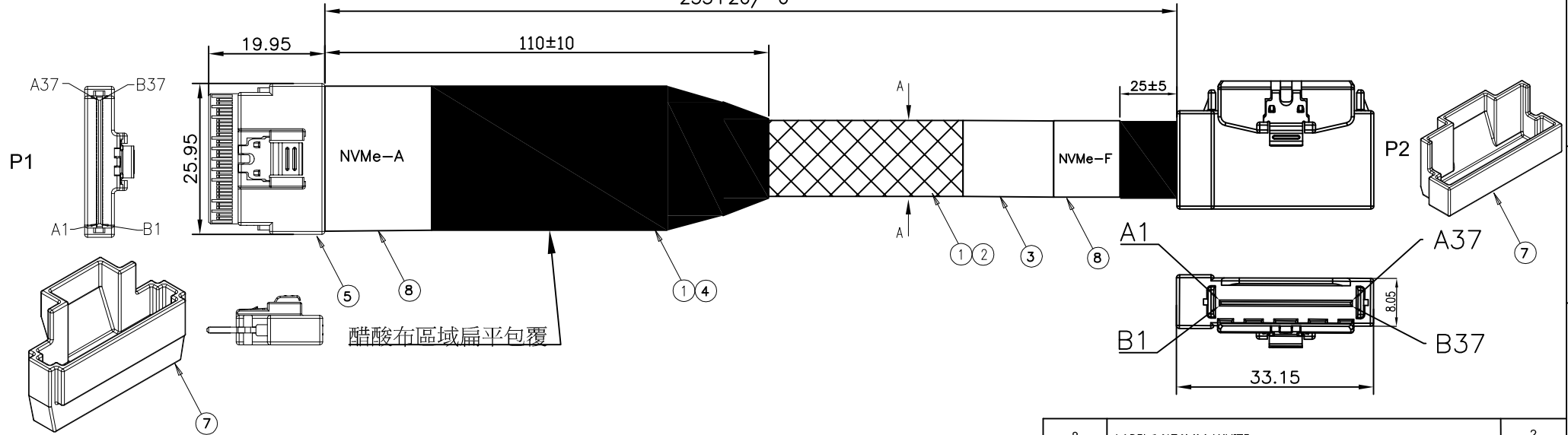

PART NO

C10 M5 1 3 B01 E 235
1 2 3 4 5 6 7

- | | |
|---|--|
| 1. SERIES NO.
C10=SATA TYPE | 4. CABLE COLOR
3=BLACK |
| 2. CONNECTOR OPTION
M5=LP SlimSAS 8X(37*2)
RS/SlimSAS 8X(37*2)STR | 5. TYPE.
6. GREEN OPTION:
E=RoHS |
| 3. STRCONNECTOR TYPE
1=M/M | 7. LENGTH NO.
235=235mm |

8	LABEL:14*74MM, WHITE	2
7	protective cover	2
6	LP 8X SlimSAS Right side,Au30u" Right side-exit	1
5	SlimSAS 8i STR,Black,V0,85Ω	1
4	ACETOUS Tape, W=1 INCH,Black	A/R
3	Label:Synthetic paper,70*40mm, WHITE	1
2	EXPANDO TUB:7.0mm,BLACK,SINGLE(OD7~25mm)	A/R
1	SAS Cable:UL20744(30#SCC/1P+2D,VW-1,85Ω,24G,YEL	A/R
ITEM	DESCRIPTION	QTY

UNLESS OTHERWISE SPECIFIED TOLERANCE
ANG. ±0°
0. ±0
.0 ±0.50
.00 ±0.30



CHANT SINCERE CO., LTD
TEL:886-02-86471251 FAX:886-02-86472962

SCALE: AS SHOWN UNIT: mm
DRAWN Yang 04/29/2019
CHECKED / /
APPROVED / /



DRAWN NAME: (PDR-18)
SAS SlimSAS 8i TO LP 8i SlimSAS Right side 1/2

PRODUCT NO. C10M513B01E235
FILE NAME: C10M513B01E235(GB)

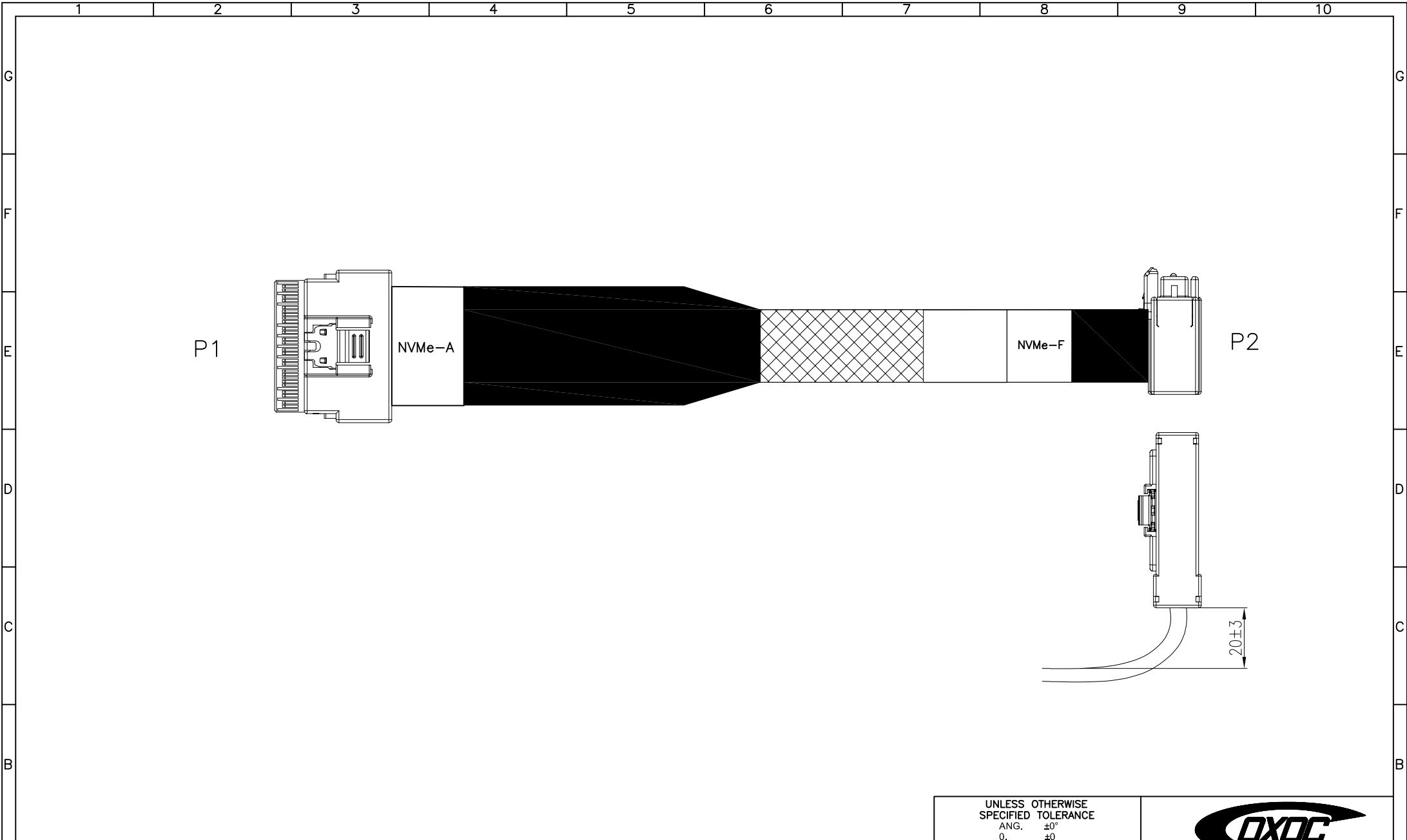
REV.	DESCRIPTION	DATE
1		
2		
3		
4		
5		
6		
7		
8		
9		
10		



REV.	DESCRIPTION	DATE

UNLESS OTHERWISE SPECIFIED TOLERANCE		 CHANT SINCERE CO., LTD TEL:886-02-86471251 FAX:886-02-86472962
ANG.	±0°	
0.	±0	
.0	±0.50	
.00	±0.30	
SCALE: AS SHOWN	UNIT: mm	DRAWN NAME: (PDR-18) SAS SlimSAS 8i TO LP 8i SlimSAS Right side 2/2 PRODUCT NO. C10M513B01E235 FILE NAME: C10M513B01E235(GB)
DRAWN Yang	04/29/2019	
CHECKED	/ /	
APPROVED	/ /	
		 SIZE A4
		REV. X8

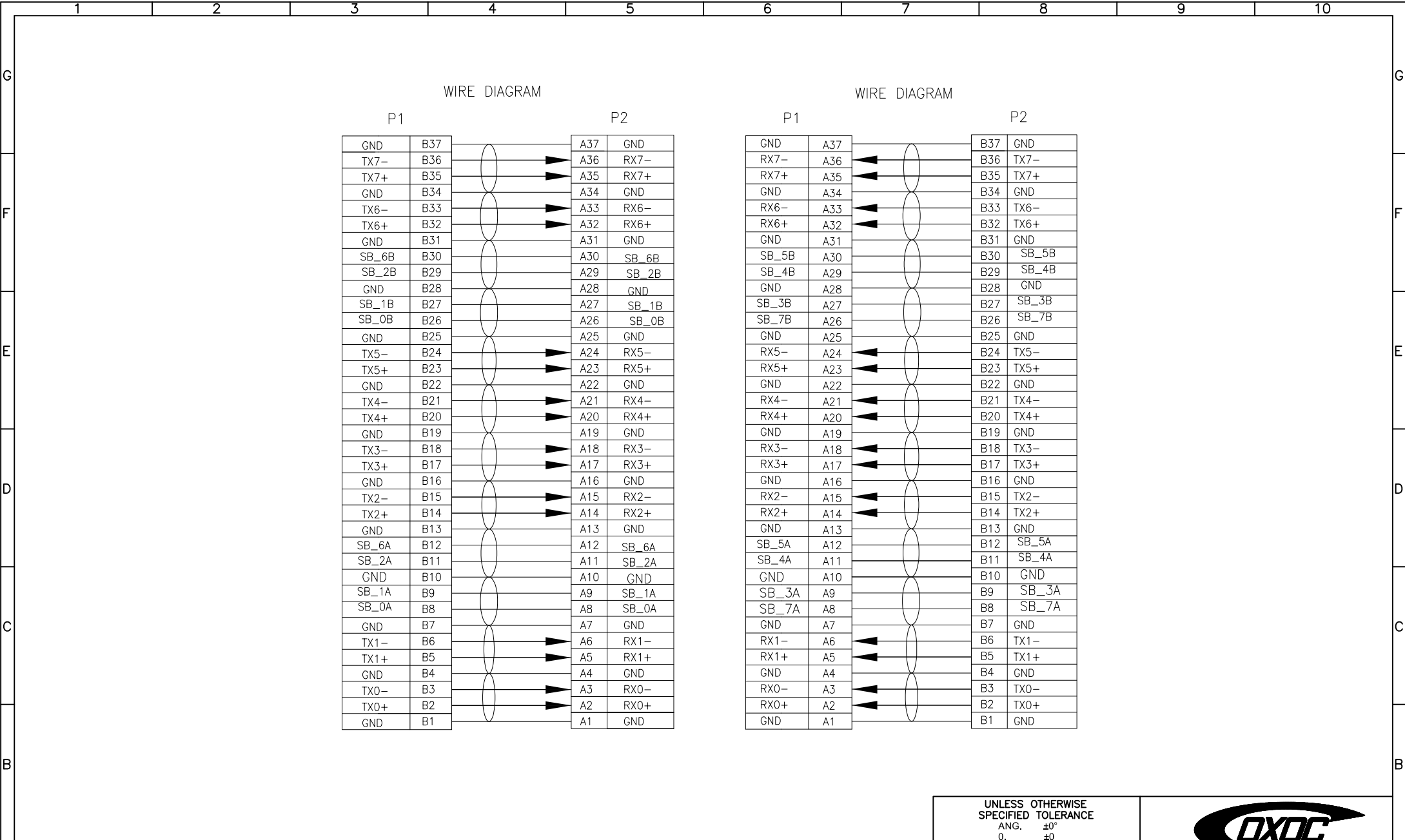

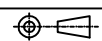
UNLESS OTHERWISE SPECIFIED TOLERANCE		 CHANT SINCERE CO., LTD TEL:886-02-86471251 FAX:886-02-86472962	
ANG. ±0° 0. ±0 .0 ±0.50 .00 ±0.30			
SCALE: AS SHOWN	UNIT: mm	DRAWN NAME: (PDR-18) SAS SlimSAS 8i TO LP 8i SlimSAS Right side 3/2 PRODUCT NO. C10M513B01E235 FILE NAME: C10M513B01E235(GB)	
DRAWN Yang	04/29/2019		
CHECKED	/ /		
APPROVED	/ /		
REV.	DESCRIPTION	DATE	 SIZE A4 REV. X8

REV.	DESCRIPTION	DATE