

PART NO.

SERIES NO. C8 FA N 3 B01 E 05C LENGTH NO. O5C=50mm
 C8=USB TYPE GREEN OPTION.
 FA=USB 3.1/SATA CONTACT TYPE E=RoHS
 N=C Plug/SATA F TYPE=B01
 CABLE COLOR 3=BLACK

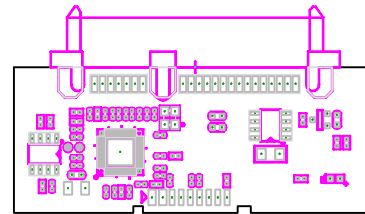

WIRE ARRANGEMENT

P1		WIRE	P2	
(Type C PLUG)	SIGNAL NAME	COLOR	(PCB)	SIGNAL NAME
A1,B1,A12,B12	GND	BLACK	9	GND
	GND_DRAIN	SDP1+SDP2 DRAIN	1	SDP1+SDP2 DRAIN
A4,B4,A9,B9	VBUS	RED	8	VBUS
A5	CC	W/RESISTOR		
B5	VCONN	N/A		
A6	Dp1	GREEN	7	D+
A7	Dn1	WHITE	6	D-
A2	SSTXp1	YELLOW	2	StdB_SSTX+
A3	SSTXn1	BLUE	3	StdB_SSTX-
B11	SSRXp1	ORANGE	4	StdB_SSRX+
B10	SSRXn1	PURPLE	5	StdB_SSRX-
SHELL	SHIELD	BRAID+DRAIN	1	SHIELD

9.	後蓋	ABS + PC 黑色 表面:鏡面拋光
8.	前殼	ABS + PC 黑色 表面:鏡面拋光
7.	PCBA	FR-4,4 層板, t=1.2
6.	Over Mold	PVC COLOR BLACK.
5.	Inner Mold	PE
4.	FOIL	COPPER FOIL.
3.	CONN P2	SATA FEMALE : 15+7 PIN 黑色膠心 LCP、端子鍍金
2.	CONN P1	USB C PLUG, BLACK INSULATOR, PCB W/RESISTOR CONTACT PLATING : 30u"Pd Ni+2u" gold, SHELL PLATED NICKEL,(W/TIN PLATE)
1.	CABLE	USB3.1 UL20276 30/30/26 ADB OD:4.8mm, BLACK PVC JACKE
NO.	TITLE	DESCRIPTION

UNLESS OTHERWISE SPECIFIED TOLERANCE
 X°±3°
 .X±0.50 .X°±2°
 .XX±0.25 .XX°±1°



CHANT SINCERE CO., LTD
 TEL:886-02-86471251 FAX:886-02-86472962

SCALE: AS SHOWN UNIT: mm
 DRAWN PEARL 04/19/2016
 CHECKED
 APPROVED

DRAWN NAME: (PDR-15051)
 Type C Plug to SATA Cable
 PRODUCT NO. C8FAN3B01E05C
 FILE NAME: C-C8FAN3B01E05C(GB)

REV.	DESCRIPTION	DATE	SIZE	REV.
1			A4	A

RoHS

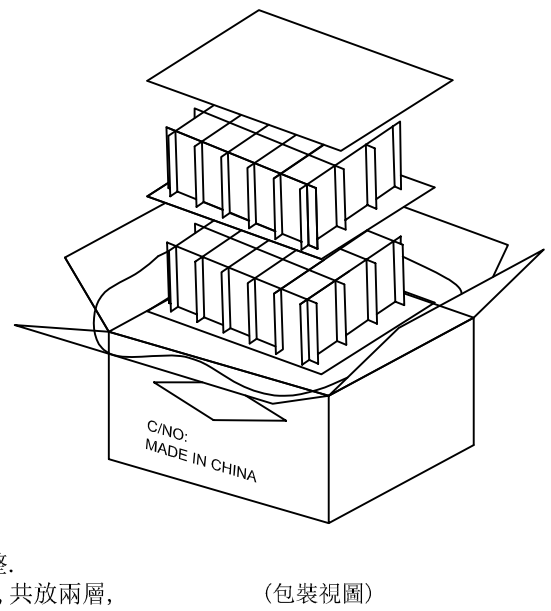
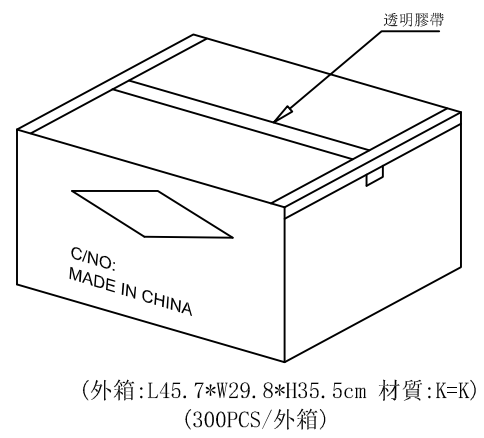
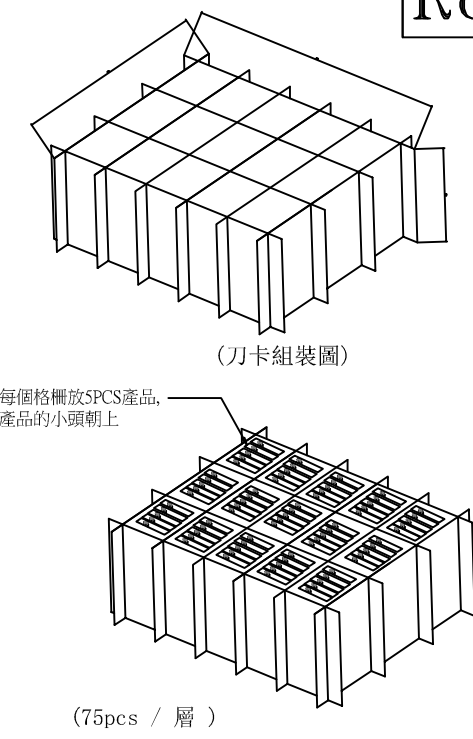
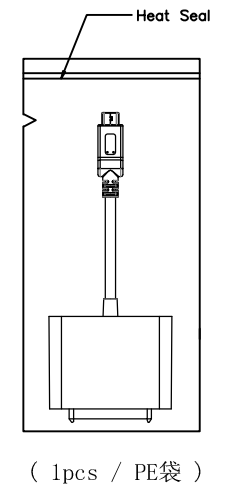
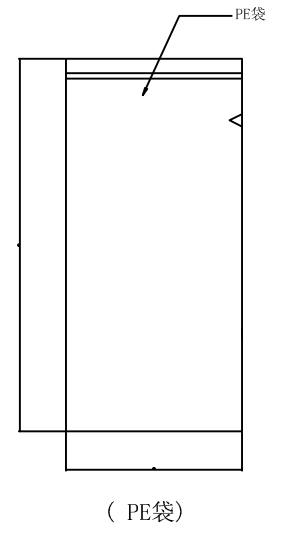
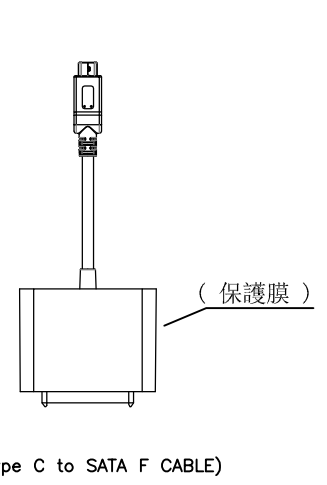

- 注:
1. 單PC成品用防靜電袋包裝, SATA端朝下.
 2. 防靜電袋熱封口時應注意熱封溫度, 且勿溫度過高, 封口要平整.
 3. 裝箱時產品要站立式放入刀卡, 刀卡每層放5PCS, 每層放75PCS, 共放兩層, 一箱放150PCS成品, 產品之間需用刀卡隔離, 每層用隔板保護, 如上圖所示.

序	料號	名稱	規格
1	M9BE18008500709	防靜電袋	防靜電袋L16.5*W6.5cm,t=0.075mm 材質PE 符合無油要求
2	M9EE029016000300	短卡板	短刀卡L29.0*W16.0cm 材質B3B,3層
3	M9EE044016000300	長刀卡	長刀卡L44.0*W16.0cm 材質B3B,3層
4	M9EE043028000300	隔板	隔板43.0*28.0cm,3層
5	M9BE87070000509	防水袋	防水袋460+410x700x0.05
1	M9CE457298355500	外箱	紙箱L45.7*W29.8*H35.5cm 材質K=K,5層

UNLESS OTHERWISE SPECIFIED TOLERANCE	
0.	±1.0
.0	±0.5
.00	±0.3



CHANT SINCERE CO., LTD
 TEL:886-02-86471251 FAX:886-02-86472962

DRAWN NAME: (PDR-15051)
 Type C Plug to SATA F CABLE L=5cm
 2/2

PRODUCT NO. C8FAN3B01E05C
 FILE NAME: C-C8FAN3B01E05C(GB)

SCALE: AS SHOWN	UNIT: mm
DRAWN PEARL	05/17/2016
CHECKED	
APPROVED	

REV.	DESCRIPTION	DATE
1		
2		
3		
4		
5		
6		

SIZE A4 REV. A