

NOTE:
 1.CABLE ASSEMBLY MUST BE RoHS COMPLIANT.
 2.CABLE MUST BE OPEN,SHORT,MISWIRE 100% TEST.
 3.USB CABLE ELECTRIC TEST:
 A.VOLTAGE: 300V DC.
 B.CONTACT RESISTENCE: 5 Ohm Max.
 C.INSULATION RESISTENCE:2M Ohm Min.

PART NO.

SERIES NO.

C8=USB TYPE

CONNECTOR OPTION

F4=USB 3.1/MICRO USB 2.0

CONNECTOR TYPE

L=CM/BM

C8 F4 L 3 A01 E 1M0

LENGTH NO.

1M0= 1000 mm

GREEN OPTION

E=RoHS

TYPE.

A01=Rd 5.1K ohm

CABLE COLOR

3=BLACK

8	Over Mold	PVC COLOR BLACK
7	INNER Mold	PE
6	FOIL	COPPER FOIL
5	TIN	TIN STICK, TIN WIRE
4	PCBA	PCBA, W/Resistor(Rd 5.1K ohm)
3	CONN#2	USB 2.0 MICRO USB M,BLACK INSULATOR, CONTACT PLATING: Au 30u" SHELL PLATED NICKEL,(W/TIN PLATE)
2	CONN#1	USB C PLUG,BLACK INSULATOR,CONTACT PLATING: Pd-Ni 30u"+Gold 2u" SHELL PLATED NICKEL,(W/TIN PLATE)
1	CABLE	USB 2.0 UL2725 28/24 ADB OD:4.0mm, BLACK PVC JACKET
NO.	TITLE	DESCRIPTION

For SIP

For CmK/Cpk

P1					P2	
USB C PLUG		WIRE			USB2.0 Micro USBM	
PIN	SIGNAL NAME	WIRE NUMBER	SIGNAL NAME	Wire COLOR & AWG	PIN	SIGNAL NAME
A1,B1,A12,B12	GND	1	GND_PWRt1	BLACK	5	GND
A4,B4,A9,B9	VBUS	2	PWR_VBUS1	RED	1	VBUS
A5	CC	W/RESISTOR				
B5	VCONN	N/A				
A6	Dp1	3	UTP_Dp	GREEN	3	D+
A7	Dn1	4	UTP_Dn	WHITE	2	D-
				N/A	4	ID
SHELL	SHIELD	BRIAD	SHIELD	BRIAD	SHELL	SHIELD

UNLESS OTHERWISE SPECIFIED TOLERANCE

ANG. ±
 0. ±1
 .0 ±0.5
 .00 ±0.25

SCALE: AS SHOWN

UNIT: mm

DRAWN Vicky

08/18/2016

CHECKED JKC

08/18/2016

APPROVED

//

SIZE A4

REV. AX1

OXOC
 CHANT SINCERE CO.,LTD
 TEL:886-02-86471251 FAX:886-02-86472962

DRAWN NAME: (PDR-14093)

USB C PLUG to 2.0 MICRO USB M CABLE 1/2

PRODUCT NO.: C8F4L3A01E1M0

FILE NAME: C-C8F4L3A01E1M0(GB)

REV.	DESCRIPTION	DATE
1		

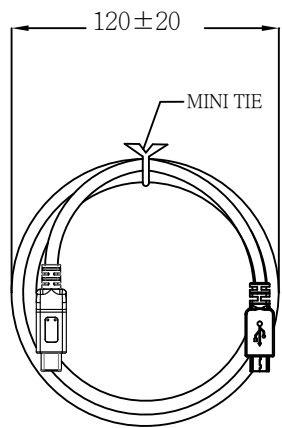

USB C/Micro USB 2.0 CABLE

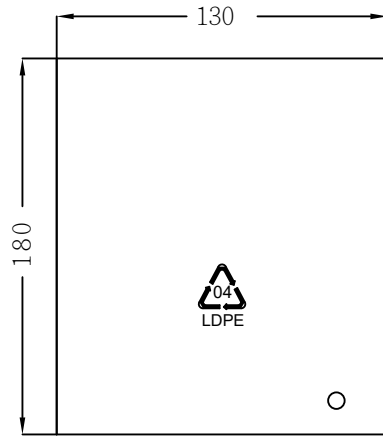

PE BAG:L180*W130*T0.05mm

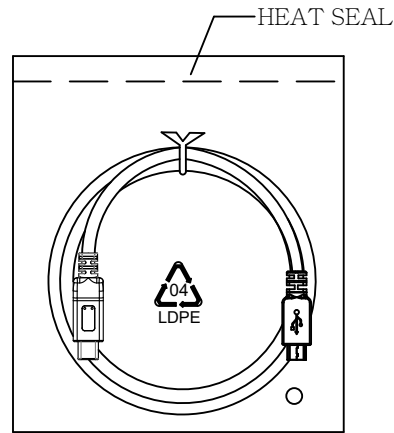

1PCS CABLE/PE BAG

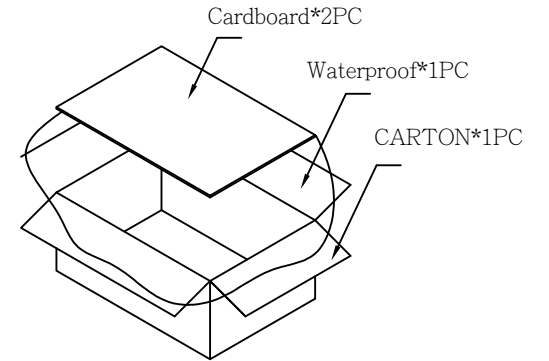

(CARTON:L457*W298*H228mm Material K=K)

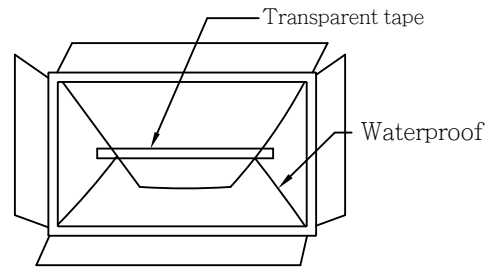

(After the installed Product, carton sealing tape should be transparent)

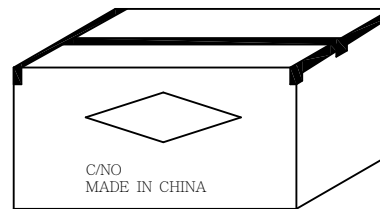

(CARTON:L457*W298*H228mm,Material K=K)
(200PCS CABLE/CARTON)

PO NO:	
ITEM NO:	
QTY:	PCS
N.W.:	KGS
G.W.:	KGS
MEAS:	1.1'

(CARTON SIDE)

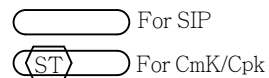

UNLESS OTHERWISE SPECIFIED TOLERANCE	
ANG.	±
0.	±1
.0	±0.5
.00	±0.25
SCALE: AS SHOWN	UNIT: mm
DRAWN Vicky	08/18/16
CHECKED Jackyc	08/18/16
APPROVED	//
SIZE A4	REV. AX1



CHANT SINCERE CO.,LTD

TEL:886-02-86471251 FAX:886-02-86472962

DRAWN NAME: (PDR-14093)

USB C PLUG to 2.0 MICRO USB M CABLE 2/2

PRODUCT NO.: C8F4L3A01E1M0

FILE NAME: C-C8F4L3A01E1M0(GB)

REV.	DESCRIPTION	DATE
1		
2		
3		
4		
5		
6		