

1000±50

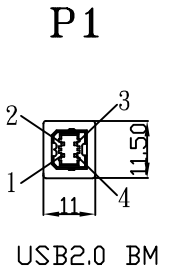
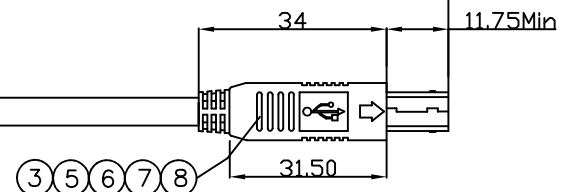

NOTE:  
 1.CABLE ASSEMBLY MUST BE RoHS COMPLIANT.  
 2.CABLE MUST BE OPEN,SHORT,MISWIRE 100% TEST.  
 3.USB CABLE ELECTRIC TEST:  
 A.VOLTAGE: 300V DC.  
 B.CONTACT RESISTANCE: 5 Ohm Max.  
 C.INSULATION RESISTANCE:2M Ohm Min.

PART NO. \_\_\_\_\_  
 SERIES NO. \_\_\_\_\_  
 C8=USB TYPE  
 CONNECTOR OPTION \_\_\_\_\_  
 F2=USB 3.1/USB 2.0  
 CONNECTOR TYPE \_\_\_\_\_  
 L=CM/BM \_\_\_\_\_

LENGTH NO. \_\_\_\_\_  
 1M0=1000 mm  
 GREEN OPTION \_\_\_\_\_  
 E=RoHS TYPE.  
 A01=Rd 5.1K ohm  
 CABLE COLOR \_\_\_\_\_  
 3=BLACK

8	Over Mold	PVC COLOR BLACK
7	INNER Mold	PE
6	FOIL	COPPER FOIL
5	TIN	TIN STICK, TIN WIRE
4	PCBA	PCBA, W/Resistor(Rd 5.1K ohm)
3	CONN P2	USB 2.0 BM, BLACK INSULATOR, CONTACT PLATING: Au 30u' SHELL PLATED NICKEL,(W/TIN PLATE)
2	CONN P1	USB C PLUG, BLACK INSULATOR,CONTACT PLATING : Pd-Ni 30u'+Gold 2u' SHELL PLATED NICKEL,(W/TIN PLATE)
1	CABLE	USB 2.0 UL2725 28/24 ADB DD:4.0mm, BLACK PVC JACKET
NO.	TITLE	DESCRIPTION

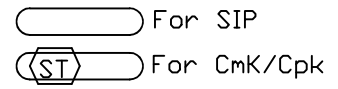

P1		WIRING DIAGRAM			P2	
USB C PLUG		WIRE			USB 2.0 BM	
PIN	SIGNAL NAME	WIRE NUMBER	SIGNAL NAME	COLOR AWG	PIN	SIGNAL NAME
A1,B1,A12,,B12	GND	1	GND_PWRrt1	BLACK	4	GND
A4,B4,A9,B9	VBUS	2	PWR_VBUS1	RED	1	VBUS
A5	CC	W/RESISTOR				
B5	vconn	N/A				
A6	Dp1	3	UTP_Dp	GREEN	3	D+
A7	Dn1	4	UTP_Dn	WHITE	2	D-
SHELL	SHIELD	BRIAD	SHIELD	BRIAD	SHELL	SHIELD

UNLESS OTHERWISE SPECIFIED TOLERANCE  
 ANG. ±  
 0. ±1  
 .0 ±0.5  
 .00 ±0.25

SCALE: AS SHOWN UNIT: mm

DRAWN Vicky 05/02/2018 DRAWN NAME: (PDR-14095)  
 CHECKED USB C PLUG to 2.0 BM CABLE 1/2

APPROVED / / PRODUCT NO: C8F2L3A01E1M0

REV. B FILE NAME: C-C8F2L3A01E1M0(GB)

CHANT SINCERE CO.,LTD  
 TEL:886-02-86471251 FAX:886-02-86472962

REV.	DESCRIPTION	DATE	SIZE A4	REV. B	FILE NAME: C-C8F2L3A01E1M0(GB)
------	-------------	------	---------	--------	--------------------------------

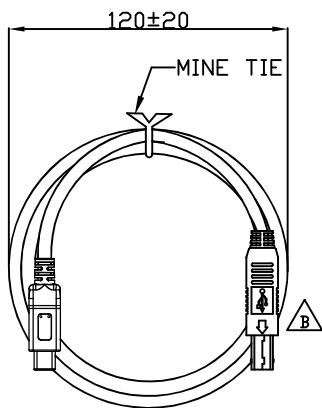

USB C/AM 2.0 CABLE

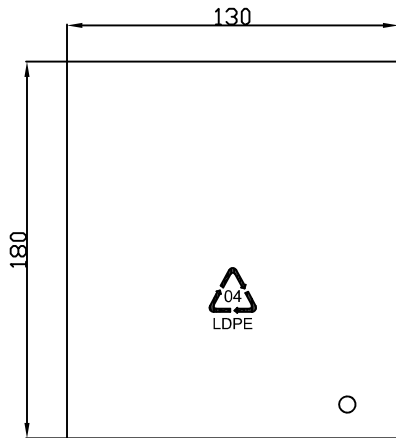

PE BAG:L180\*W130\*T0.05mm

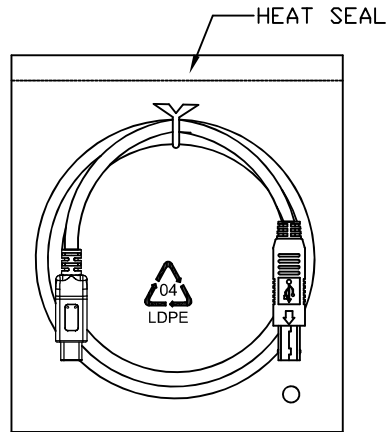

1PC CABLE/PE BAG

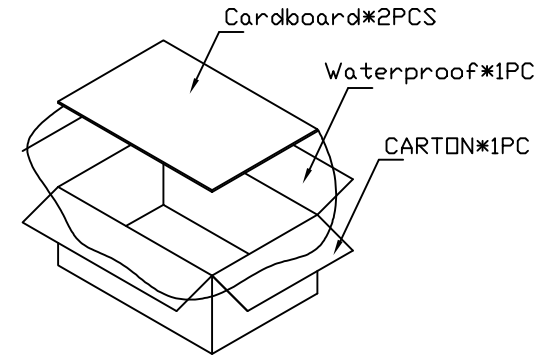

(CARTON:L457\*W298\*H228mm Material K=K)

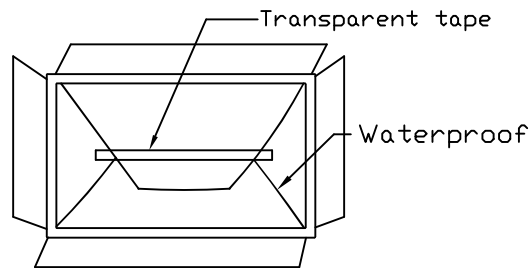

(After the installed Product, carton sealing tape should be transparent)

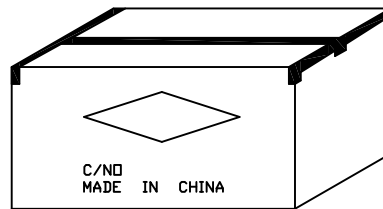

(CARTON:L457\*W298\*H228mm,Material K=K)  
(200PCS CABLE/CARTON)

PO NO:	
ITEM NO:	
QTY:	PCS
N.W.:	KGS
G.W.:	KGS
MEAS:	1.1'

(CARTON SIDE)

○ For SIP  
 (ST) For CmK/Cpk

UNLESS OTHERWISE SPECIFIED TOLERANCE		 <b>CHANT SINCERE CO.,LTD</b> TEL:886-02-86471251 FAX:886-02-86472962	
ANG.	±		
0.	±1	SCALE: AS SHOWN	UNIT: mm
.0	±0.5	DRAWN Vicky	05/02/2018
.00	±0.25	CHECKED	
		APPROVED	/ /
			PRODUCT NO: C8F2L3A01E1M0
			FILE NAME: C-C8F2L3A01E1M0(GB)

REV.	DESCRIPTION	DATE
1		
2		
3		
4		
5		
6		

DRAWN NAME: (PDR-14095)  
 USB C PLUG to 2.0 BM CABLE 2/2