

RoHS compliant

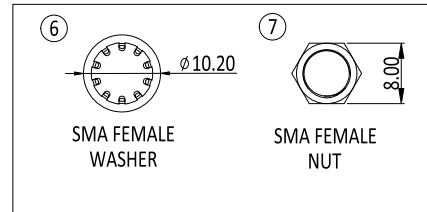
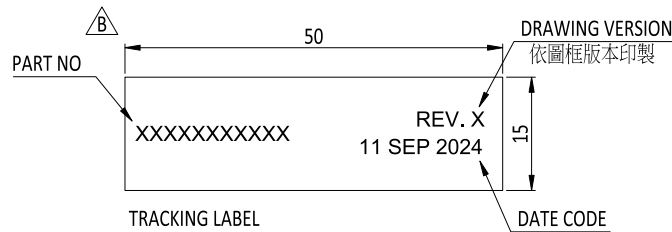
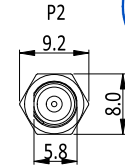
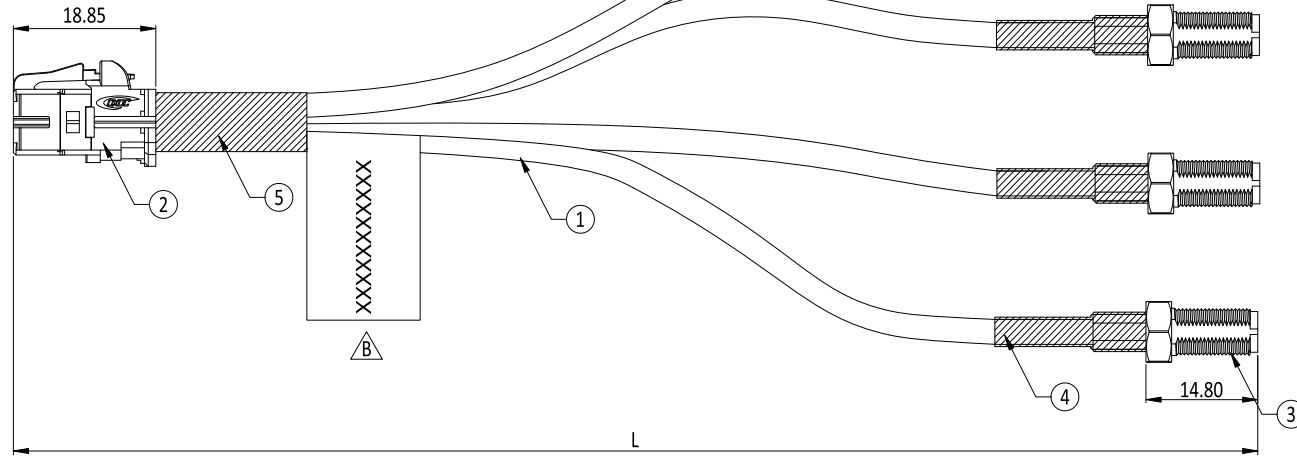
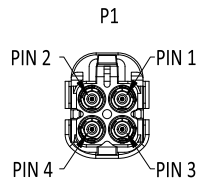

SPECIFICATION
ELECTRICAL CHARACTERISTIC:
 1. CHARACTERISTIC IMPEDANCE: 50 Ω
 2. FINISHED CABLE 100% CONDUCTIVITY TEST

ENVIRONMENTAL :
 1. OPERATING TEMPERATURE RANGE: -40°C TO +105°C

TRACKING LABEL
 1. FONT: ARIAL, H=2.00mm
 2. WHITE LABEL WITH BLACK TEXT

7	NUT	BRASS, AU PLATED	1
6	WASHER	BRASS, AU PLATED	1
5	HST	HEAT SHRINK TUBE, BLACK	1
4	HST	HEAT SHRINK TUBE, BLACK	4
3	SMA JACK	TEFLON UL94V-0, 1u" AU	4
2	MINI FAKRA B 2x2 JACK	PA66 UL94V-0, 30u" AU	1
1	O31 CABLE	22AWG COAXIAL+AL+MYLAR+BRAID, OD: 3.2mm, JACKET: PVC BLACK	A/R
ITEM	DESCRIPTION	MATERIAL	Q'TY

X-CODING(SEE PAGE 2/2)

1	1424302001X	C7S8FXX3A0XE1M0	1000±30mm	
ITEM	NEW P/N	OLD P/N	L (LENGTH)	NOTE
UNLESS OTHERWISE SPECIFIED TOLERANCE		SIP Cmk Cpk		 CHANT SINCERE CO.,LTD
ANG. ±5° 0. ±0.50 .0. ±0.30 .00 ±0.20		UNIT: mm		
SCALE: 2:1		DRAWN: HOLLY_TU		TITLE: PDR-20032
		31 Jul 2025		MINI FAKRA B 2x2 JACK TO SMA JACK x4 CABLE
		CHECKED: VICKY_HSIEH		PART NO. 1424302XXXX
		31 Jul 2025		CODE: GC
		APPROVED: JASON_HUANG		CUSTOMER:
		31 Jul 2025		
		REV. C		

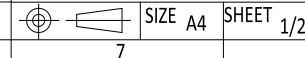

B3	C	ECN-2507131(HOLLY)MODIFY HST & MINI FAKRA B 2x2 JACK	27JUL2025
D3, E4	B	ECN-2409036(TINA)ADD LABEL & PAGE 3/3	11SEP2024
	A	ECN-2308066(JOLIN)NEW DRAWN	28AUG2023
ZONE	REVISION	DESCRIPTION	DATE





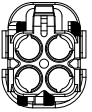
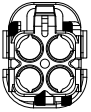
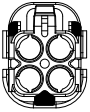
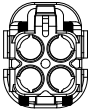
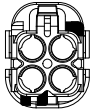

RoHS
compliant

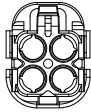

MINI FAKRA B

A	B	C	D	E	F	Z
JET BLACK SIMILAR RAL 9005	PURE WHITE SIMILAR RAL 9010	LIGHT BLUE SIMILAR RAL 5012	CLARET VIOLET SIMILAR RAL 4004	MAY GREEN SIMILAR RAL 6017	NUT BROWN SIMILAR RAL 8011	WATER BLUE SIMILAR RAL 5021
						

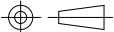
UNLESS OTHERWISE SPECIFIED TOLERANCE		 SIP  Crk  Cpk	 CHANT SINCERE CO.,LTD
ANG.	$\pm 5^\circ$ ± 0.50 ± 0.30 ± 0.20		
SCALE:	2:1	UNIT:	mm
DRAWN:	HOLLY_TU	31 Jul 2025	TITLE: PDR-20032
CHECKED:	VICKY_HSIEH	31 Jul 2025	MINI FAKRA B 2x2 JACK TO SMA JACK x4 CABLE
APPROVED:	JASON_HUANG	31 Jul 2025	PART NO. 1424302XXXX
	SIZE A4	SHEET 2/3	REV. C
ZONE	REVISION	DESCRIPTION	DATE

C	ECN-2507131(HOLLY)SEE PAGE 1/3	29JUL2025
B	ECN-2409036(TINA)ADD PAGE 3/3	11SEP2024
A	ECN-2308066(JOLIN)NEW DRAWN	28AUG2023

RoHS compliant

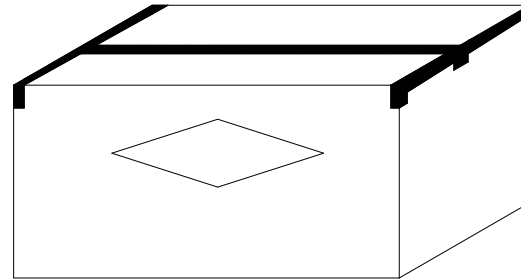
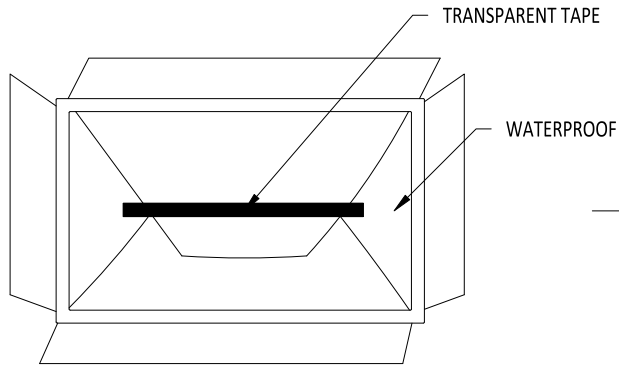
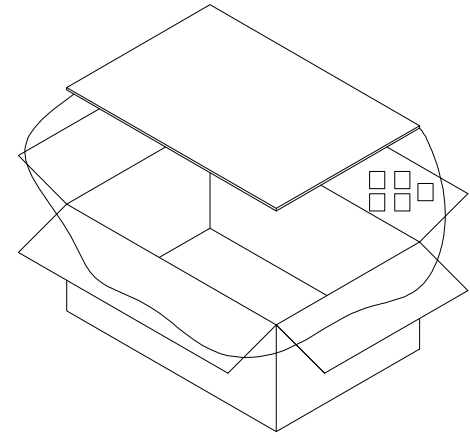
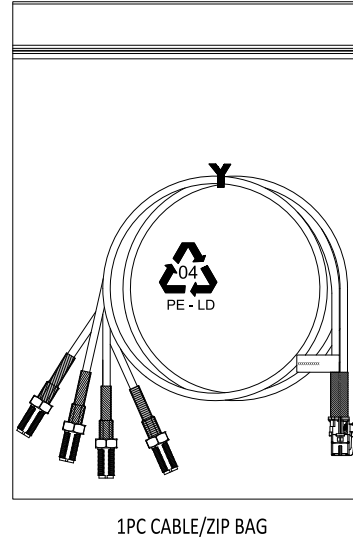
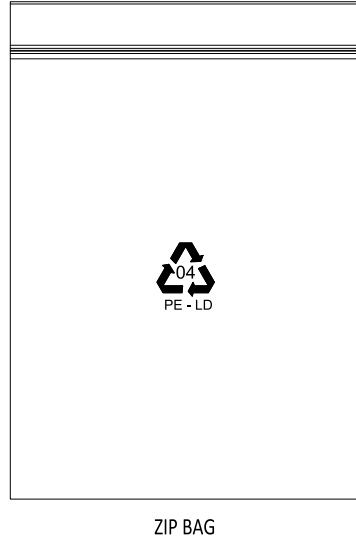
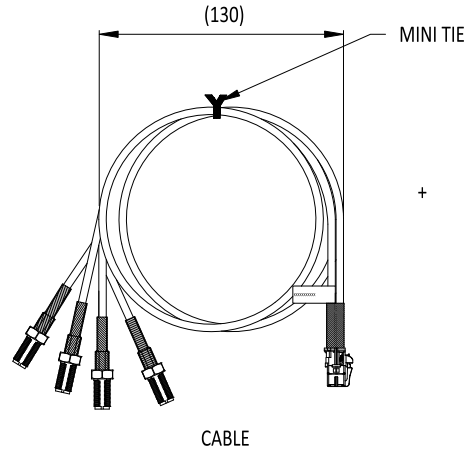

(THE PACKING QUANTITY IS BASED ON THE FIRST BATCH OF ACTUAL ORDER)

(AFTER THE INSTALLED PRODUCT, CARTON SEALING TAPE SHOULD BE TRANSPARENT)

5	DESICCANT	M90000EZ0000029	2g	5 PCS	
4	WATERPROOF	M9BE91461007009	914x610x0.07mm	1 PC	
3	CARDBOARD(B3B)	M9DE295450000500	295x450mm	2 PCS	
2	CARTON	M9CE451330229500	17.75"x13"x9"	1 PC	
1	ZIP BAG	M9BE2401700081I	240(L)x170(W)mm	1PC/ZIP BAG	
ITEM	DESCRIPTION	PART NUMBER	SPECIFICATION	Q'TY	NOTE

UNLESS OTHERWISE SPECIFIED TOLERANCE		SIP
ANG.	±5°	Crk Cpk
0.	±0.50	
.0.	±0.30	
.00	±0.20	

OXOC

CHANT SINCERE CO.,LTD

SCALE: AS SHOWN UNIT: mm

DRAWN: HOLLY_TU 31 Jul 2025

CHECKED: VICKY_HSIEH 31 Jul 2025

APPROVED: JASON_HUANG 31 Jul 2025

TITLE: PDR-20032

MINI FAKRA B 2x2 JACK TO SMA JACK x4 CABLE

PART NO. 1424302XXXX

CODE: GC CUSTOMER:

	C	ECN-2507131(HOLLY)SEE PAGE 1/3	29JUL2025
	B	ECN-2409036(TINA)ADD PAGE 3/3	11SEP2024
	A	ECN-2308066(JOLIN)NEW DRAWN	28AUG2023
ZONE	REVISION	DESCRIPTION	DATE

SIZE A4 SHEET 2/3

REV. C