

RoHS compliant

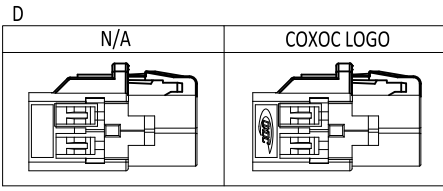
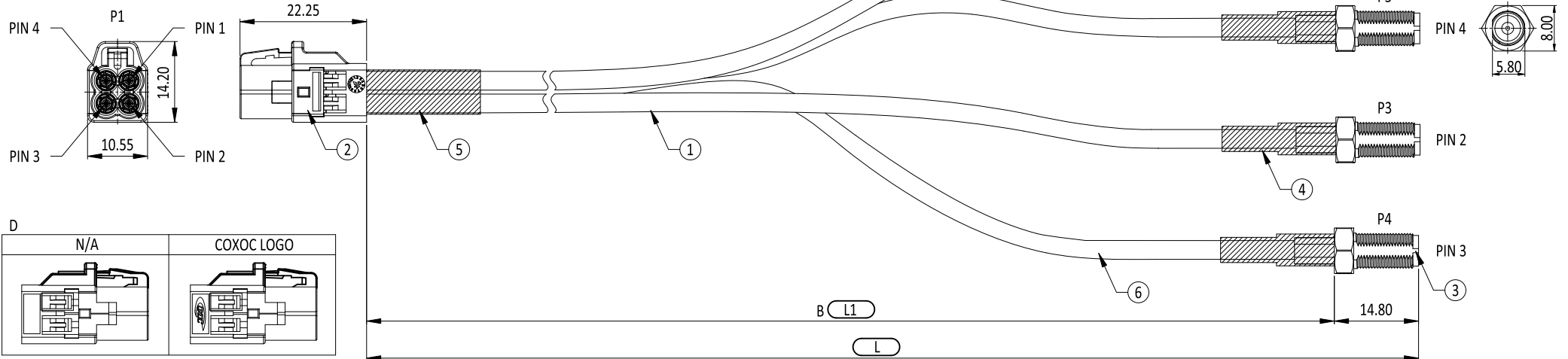

SPECIFICATION
MATERIAL AND FINISH:
 1. CODING HOUSING: PBT, COLOR SEE PAGE 2

ELECTRICAL CHARACTERISTIC:
 1. CHARACTERISTIC IMPEDANCE: 50 Ω
 2. FINISHED CABLE 100% CONDUCTIVITY TEST

ENVIRONMENTAL :
 1. OPERATING TEMPERATURE RANGE: -40°C TO +105°C

LENGTH TOTAL TOLERANCE:
 1M > L ±15mm
 2M > L ≥ 1M ±30mm
 5M > L ≥ 2M ±50mm
 10M > L ≥ 5M ±100mm
 L ≥ 10M ±150mm

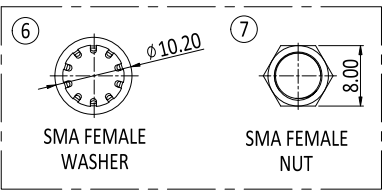

7	NUT	BRASS, AU PLATED	4
6	WASHER	BRASS, AU PLATED	4
5	HST	HEAT SHRINK TUBE, BLACK	1
4	HST	HEAT SHRINK TUBE, BLACK	4
3	SMA JACK C	TEFLON, 1u" AU	4
2	MINI FAKRA A 2x2 JACK	THERMOPLASTIC, UL94V-0, 30u" AU	1
1	CABLE	22AWG COAXIAL+AL+MYLAR+BRAID, OD: 3.3mm, JACKET: PVC BLACK	4

ITEM	PART NAME	DESCRIPTION	Q'TY
B6, C6, E1	D	ECN-2511088(JOAN)ADD P/N · ADD LOGO	14NOV2025
B1	C	ECN-2503005(VICKY_HSIEH)MODIFY PART NAME · MATERIAL & SEE PAGE 3/3	03MAR2025
6B, 6D, 8B	B	ECN-2411033(KEVIN)ADD L1=40mm OPTION	08NOV2024
ZONE	REVISION	DESCRIPTION	DATE

X=CODING(SEE PAGE 2/3)

D 4	1420301014X	L	1800±30mm	COXOC LOGO
D 3	1420301013X	L	300±15mm	COXOC LOGO
B 2	1420301012X	L1	40±10mm	N/A
1	1420301011X	L	1000±30mm	N/A

ITEM	P/N	B LENGTH	LOGO	NOTE
UNLESS OTHERWISE SPECIFIED TOLERANCE		SIP Cmk Cpk		
SCALE: 1:1		UNIT: mm		
DRAWN: KEVIN_ZHENG		21 Nov 2025		
CHECKED: PEARL_HUNG		24 Nov 2025		
APPROVED: PEARL_HUNG		24 Nov 2025		
TITLE: MINI FAKRA A 2x2 JACK TO SMA JACK x4 CABLE		PART NO. 1420301XXXX		
CODE: GC		CUSTOMER:		



RoHS
compliant



A	B	C	D	E	F	Z
JET BLACK SIM. 9005	PURE WHITE SIM. 9010	LIGHT BLUE SIM. 5012	CLARET VIOLET SIM. 4004	MAY GREEN SIM. 6017	NUT BROWN SIM. 8011	WATER BLUE SIM. 5021

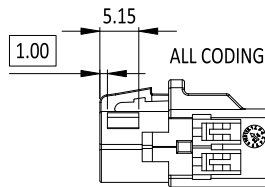

UNLESS OTHERWISE SPECIFIED TOLERANCE		SIP
ANG.	±5°	Cmk Cpk
0.	±0.50	
.0	±0.30	
.00	±0.20	

CHANT SINCERE CO.,LTD

	D	ECN-2511088(JOAN)SEE PAGE 1/3	14NOV2025	DRAWN: KEVIN_ZHENG	21 Nov 2025	TITLE:	MINI FAKRA A 2x2 JACK TO SMA JACK x4 CABLE	
	C	ECN-2503005(VICKY_HSIEH) SEE PAGE 1/3 & 3/3	03MAR2025	CHECKED: PEARL_HUNG	24 Nov 2025	PART NO.	1420301XXXX	
	B	ECN-2411033(KEVIN)SEE PAGE 1/3	08NOV2024	APPROVED: PEARL_HUNG	24 Nov 2025	REV.	D	
ZONE	REVISION	DESCRIPTION	DATE		SIZE A4	SHEET 2/3	CODE: GC	CUSTOMER:

RoHS compliant

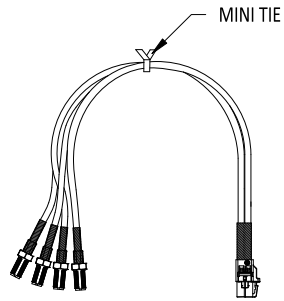

MINI FAKRA A 2x2 JACK TO SMA JACK x4 CABLE

+

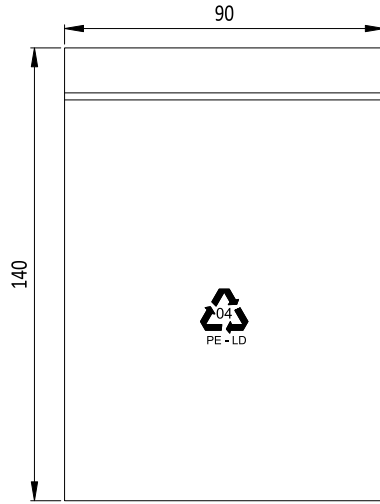

ZIP BAG: 240(L)x170(W)mm

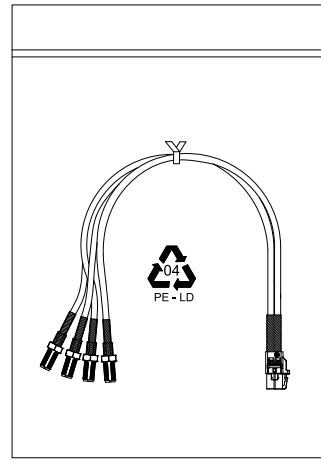

1PC CABLE/ZIP BAG

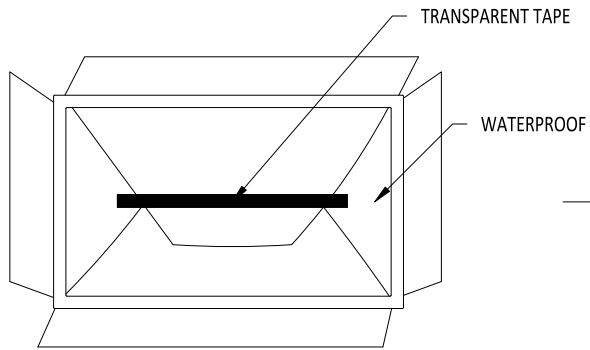
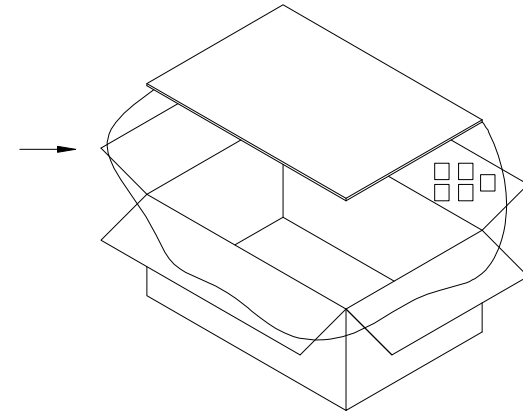

(AFTER THE INSTALLED PRODUCT, CARTON SEALING TAPE SHOULD BE TRANSPARENT)

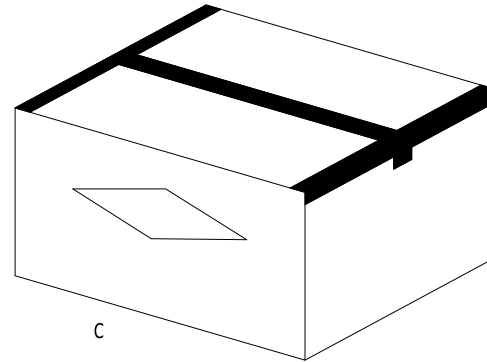

(THE PACKING QUANTITY IS BASED ON THE FIRST BATCH OF ACTUAL ORDER)

5	DESICCANT	M90000E20000029	2g	5 PCS/CARTON	
4	WATERPROOF	M9BE71163507009	28"x25"x0.07mm	1 PC/CARTON	
3	CARDBOARD(B3B)	M9EE330330000300	330x330mm	2 PCS/CARTON	
2	CARTON	M9CE406330165500	16"x13"x6.5"	1 PC/CARTON	
1	ZIP BAG	C M9BE2401700081I	240(L)x170(W)mm	1 PC CABLE/ZIP BAG	
ITEM	DESCRIPTION	PART NUMBER	SPECIFICATION	Q'TY	NOTE

	D	ECN-2511088(JOAN)SEE PAGE 1/3			14NOV2025
A2, C5	C	ECN-2503005(VICKY_HSIEH)MODIFY ZIP BAG、BOX PRINTING & SEE PAGE 1/3			03MAR2025
	B	ECN-2411033(KEVIN)SEE PAGE 1/3			08NOV2023
ZONE	REVISION	DESCRIPTION			DATE

UNLESS OTHERWISE SPECIFIED TOLERANCE	
ANG.	±5°
0.	±0.50
.0	±0.30
.00	±0.20

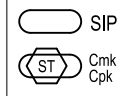

SCALE: AS SHOWN	UNIT: mm
DRAWN: KEVIN_ZHENG	21 Nov 2025
CHECKED: PEARL_HUNG	24 Nov 2025
APPROVED: PEARL_HUNG	24 Nov 2025
SIZE A4	SHEET 3/3
REV. D	

TITLE: MINI FAKRA A 2x2 JACK TO SMA JACK x4 CABLE	
PART NO.	1420301XXXX
CODE: GC	CUSTOMER: