

DETAIL A
1:1

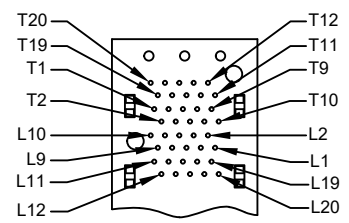

CONNECTOR PIN-OUT
COMPONENT SIDE OF BOARD

NOTES:
 MATERIAL:
 CAGE: COPPER ALLOY
 CONNECTOR:
 PLASTIC HOUSING: HIGH TEMPERATURE LCP, UL94 V-0.
 LIGHT PIPE: POLYCARBONATE; COLOR: CLEAR
 SPRING: STAINLESS STEEL
 CONTACTS: PHOSPHOR BRONZE
 CONTACT PLATING: 15u" MIN. GOLD ON MATING AREA,
 150u" MATTE TIN ON SOLDER TAILS
 PACKAGING: TRAY PACKAGING.
 TEMPERATURE RANGE: -40°C TO +85°C

PART NUMBER:
 902 G H B2 B C T A2 X 1 A 3
 T 2 3 4 5 6 7 8 9 10 11 12

- SERIES NO.
- TYPE: G=PressFit
- GREEN OPTION:
H=RoHS+HF(Matte Plated)
- PORT NO:
B2=2x2
- CONTACT TYPE:
B=Female
- CONTACT PLATING:
C=15u" Gold
- SOLDER TAILS AREA PLATING:
T=Tin plated
- TYPE OPTION:
A2=SFP+ ASSEMBLY
- SHELL PLATING/TYPE:
0=Non Plating/Spring
N=Ni Plating(50u" Min)/Spring
- PROCESS OPTION:
1=With Inner&Outer Light Pipe
- PACKAGE OPTION:
A=Tray
- INSULATOR COLOR:
3=Black

UNLESS OTHERWISE SPECIFIED TOLERANCE			
.X±0.20	.X±1°		
.XX±0.15	.XX±5°	CHANT SINCERE CO.,LTD TEL 886-02-86471251 FAX 886-02-86472362	
SCALE: AS SHOWN	UNIT: mm	DRAWN NAME: SFP+ 2X2 CAGE AND CONNECTOR ASSEMBLY, PRESS FIT, WITH EMI SPRINGS 1/4	
DRAWN: PEARL	07/16/2019	PRODUCT NO. 902GHB2BCTA2X1A3	
CHECKED:		FILE NAME: 902GHB2BCTA201A3(X07)	
APPROVED:			
REV.	DESCRIPTION	DATE	SIZE A4
1			REV. X2

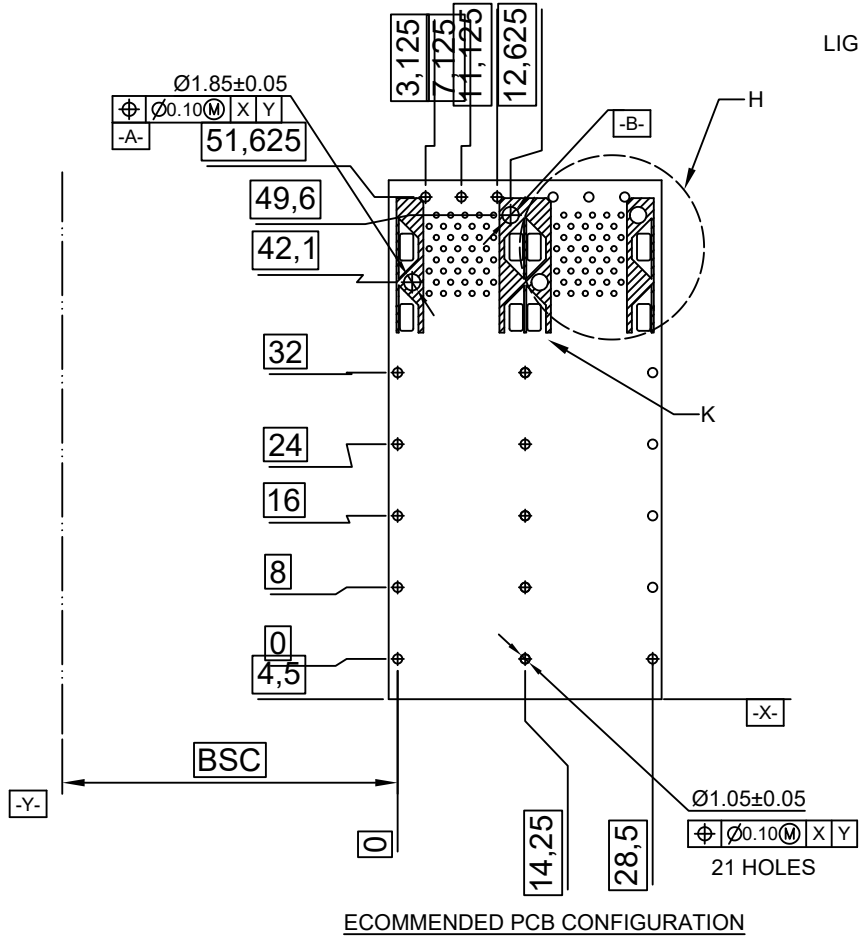

RECOMMENDED PCB CONFIGURATION

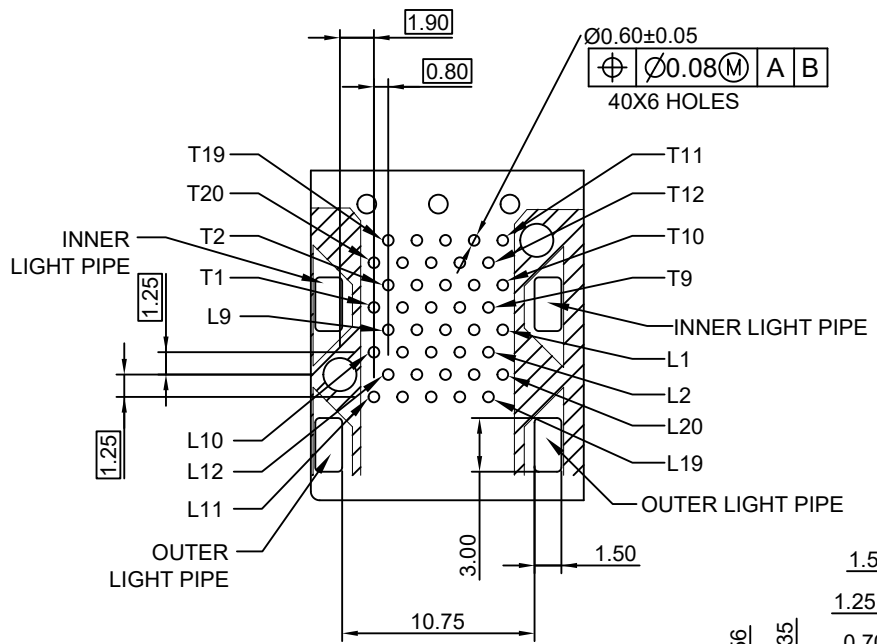

DETAIL H
2:1

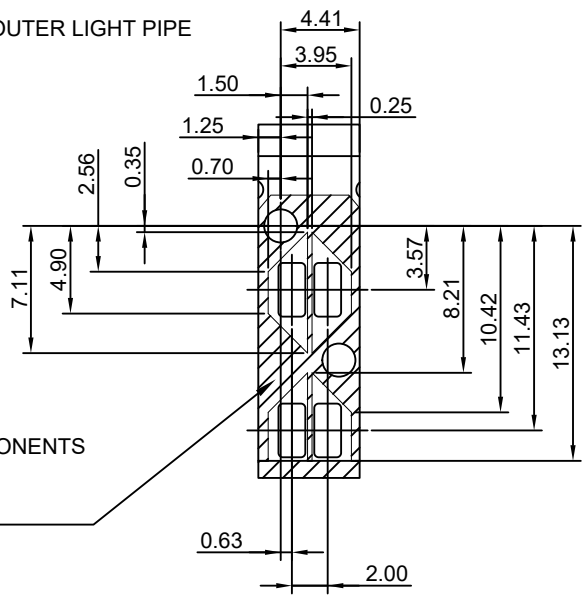

DETAIL LIGHT PIPE LOCATION AND OTHER ZONES
DETAIL K
2:1

THE ENTIRE AREA OF THE CONNECTOR FOOTPRINT TO BE CONSIDERED THE KEEP OUT AREA FOR COMPONENTS (OTHER THAN LIGHT PIPE LE'S) THIS AREA IS INDICATED BY THE DASHED LINE

UNLESS OTHERWISE SPECIFIED TOLERANCE			
.X±0.20	.X±1"		
.XX±0.15	.XX±5"	CHANT SINCERE CO.,LTD TEL:886-02-86471251 FAX:886-02-86472362	
.XXX±0.10		SCALE: AS SHOWN	UNIT: mm
		DRAWN: PEARL	07/16/2019
		CHECKED:	
		APPROVED:	
		PRODUCT NO.	902GHB2BCTA2X1A3
		FILE NAME:	902GHB2BCTA201A3(X07)

REV.	DESCRIPTION	DATE

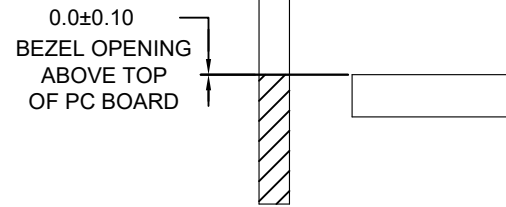
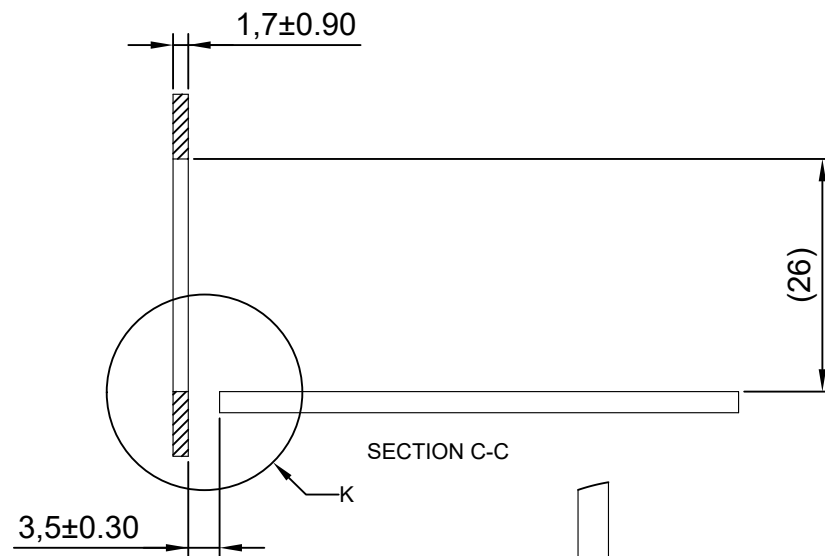
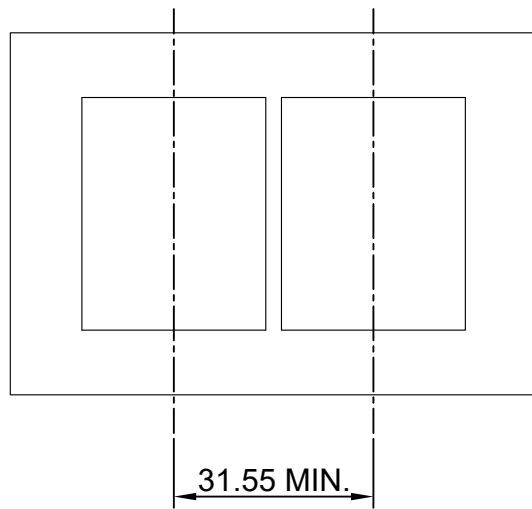
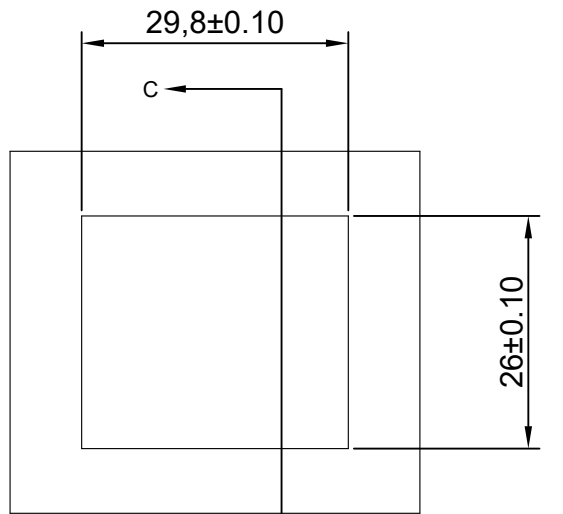

RECOMMENDED BEZEL DESIGN

UNLESS OTHERWISE SPECIFIED TOLERANCE	
.X±0.20	.X±1°
.XX±0.15	.XX±5°
.XXX±0.10	



CHANT SINCERE CO.,LTD
TEL 886-02-86471251 FAX 886-02-86472362

SCALE:	AS SHOWN	UNIT:	mm
DRAWN:	PEARL	DATE:	07/16/2019
CHECKED:			
APPROVED:			

DRAWN NAME:	SFP+ 2X2 CAGE AND CONNECTOR ASSEMBLY, PRESS FIT, WITH EMI SPRINGS 3/4
PRODUCT NO.:	902GHB2BCTA2X1A3
FILE NAME:	902GHB2BCTA201A3(X07)

REV.	DESCRIPTION	DATE

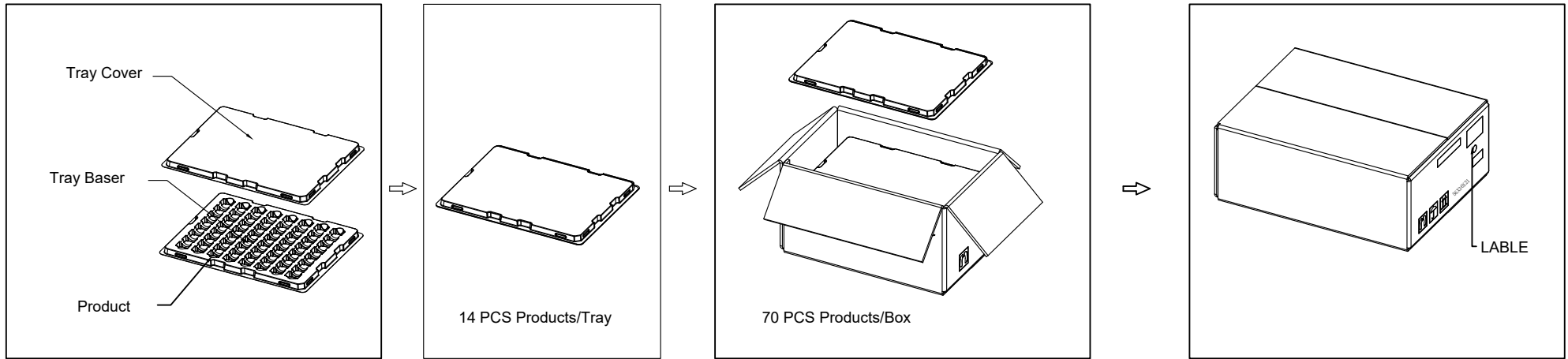

SIZE	A4	REV.	X2
------	----	------	----

PACKAGE INFORMATION AND LABLE



PACKING QUANTITY : 14 PCS FINISHED GOODS PER TRAY

5 TRAYS (70 PCS FINISHED GOODS) PER CARTON BOX

UNLESS OTHERWISE SPECIFIED TOLERANCE .X±0.20 .X±1" .XX±0.15 .XX±5" .XXX±0.10		 CHANT SINCERE CO.,LTD TEL:886-02-86471251 FAX:886-02-86472362	
SCALE: AS SHOWN	UNIT: mm		
DRAWN: PEARL	07/16/2019	DRAWN NAME: SFP+ 2X2 CAGE AND CONNECTOR ASSEMBLY, PRESS FIT, WITH EMI SPRINGS 4/4	
CHECKED:		PRODUCT NO. 902GHB2BCTA2X1A3	
APPROVED:		FILE NAME: 902GHB2BCTA201A3(X07)	
REV.	DESCRIPTION	DATE	  SIZE A4 REV. X2

1	2	3	4	5	6	7	8	9	10
---	---	---	---	---	---	---	---	---	----