

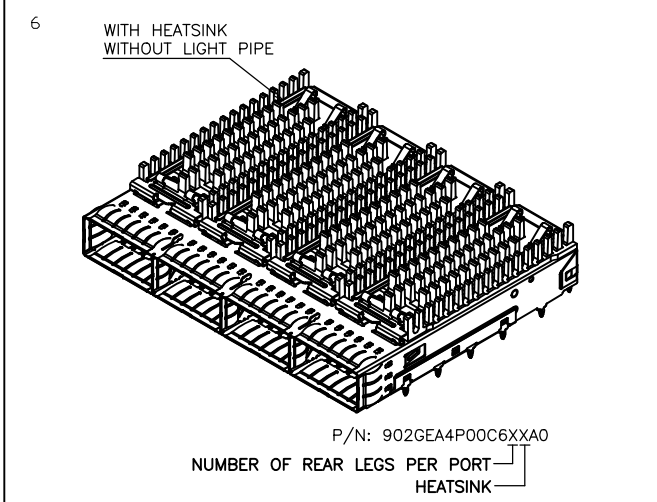

TYPE OPTIONALS, QSFP+ CAGE (STYLE A)
1X4 CAGE ASSEMBLY, SPRING FINGER, PRESS-FIT

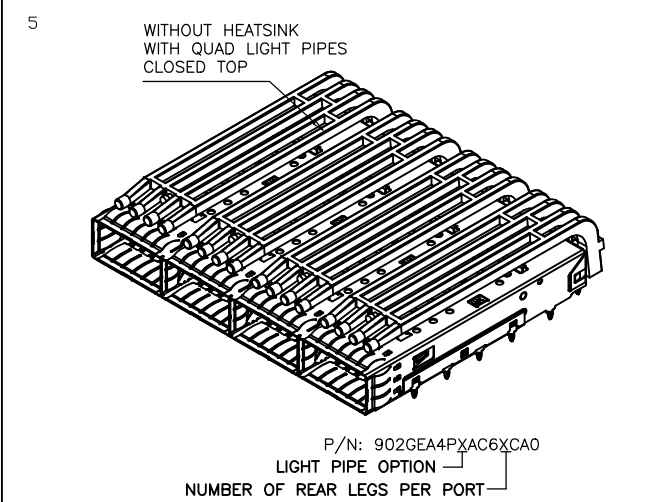
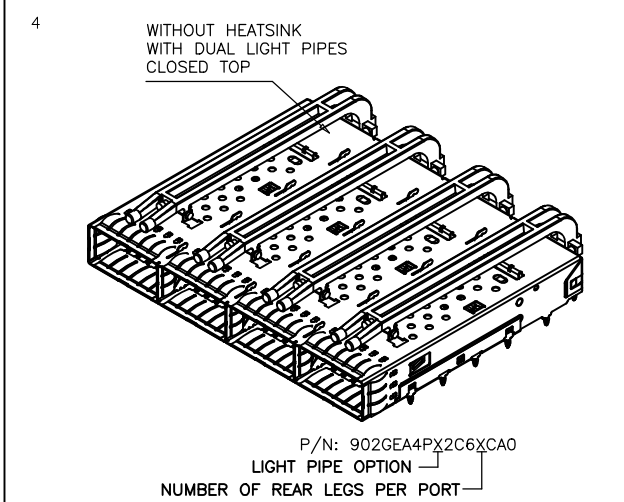
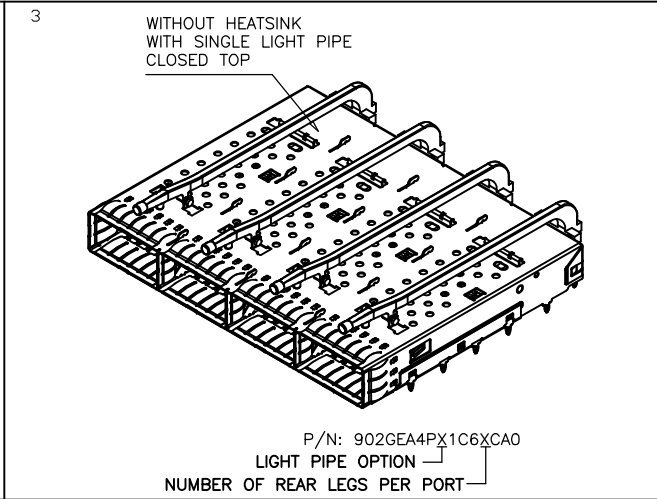
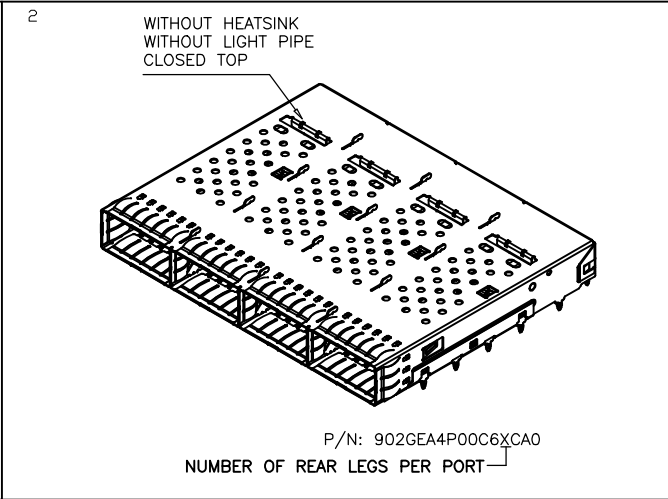
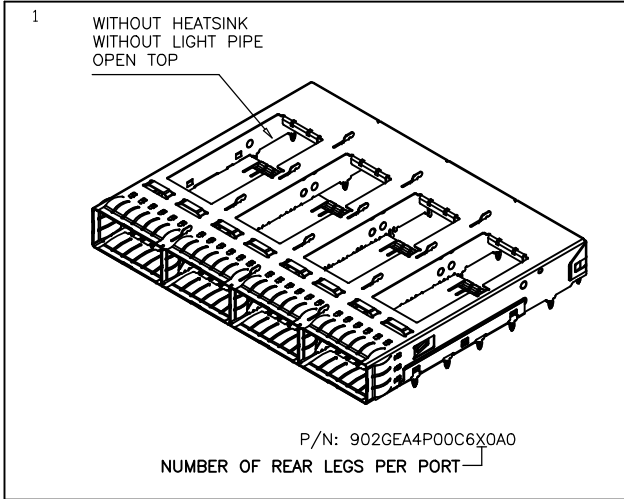

UNLESS OTHERWISE SPECIFIED TOLERANCE		 CHANT SINCERE CO.,LTD TEL:886-02-86471251 FAX:886-02-86472962
3 PLACE ± 0.1 2 PLACE ± 0.2 1 PLACE ± 0.3 ANGULAR: $X^{\circ} \pm 2'$		
SCALE: AS SHOWN	UNIT: mm	
DRAWN: EVA	11/23/2018	DRAWN NAME: QSFP+ 28G CAGE 1X4 Through Bezel 1/13
CHECKED:		PRODUCT NO. 902GEA4PXXC6XXA0
APPROVED:		FILE NAME: 902GEA4PXXC61XA0(X8)

REV.	DESCRIPTION	DATE	SIZE	REV.
1			A4	C

TYPE OPTIONALS, QSFP+ CAGE (STYLE A)
1X4 CAGE ASSEMBLY, SPRING FINGER, PRESS-FIT

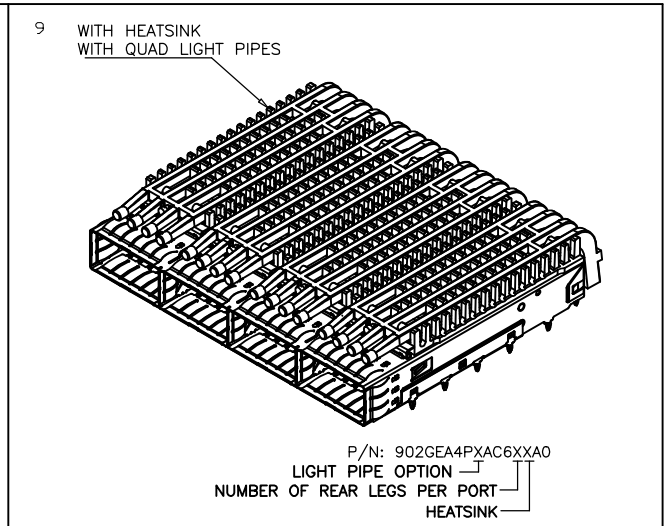
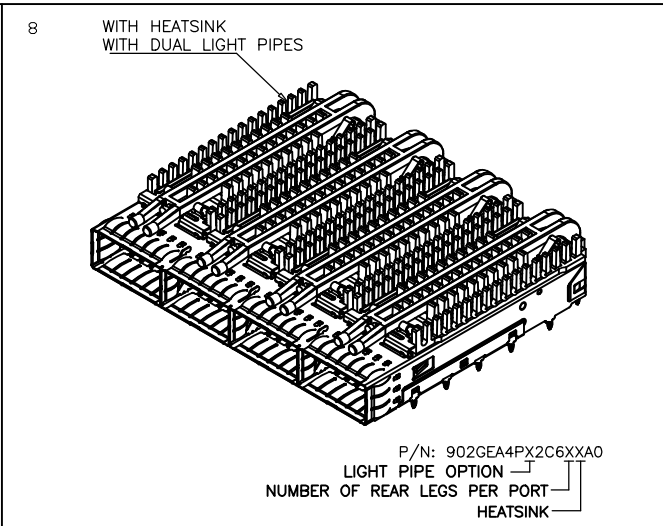
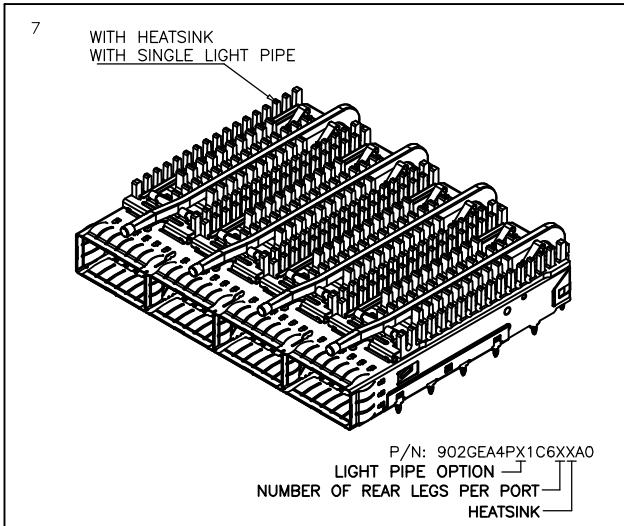

902 G E A4 P X X C6 X X A 0
1 2 3 4 5 6 7 8 9 10 11 12

- | | |
|---|------------------------------------|
| 1.SERIES NO. | 8.TYPE OPTION: C6=QSFP+ 28G Cage |
| 2.TYPE: G=PressFit | 9.SHELL PLATING/TYPE: |
| 3.GREEN OPTION: E=RoHS | 1=NO Plating/Through Bezel |
| 4.PORT NO: A4=1x4 | 7=NO Plating/Through Bezel(1 Legs) |
| 5.CONTACT TYPE: P=Non Distribution | 10.PROCESS OPTION: |
| 6.LIGHT PIPE OPTION: | 0=W/O Heatsink, Open Top |
| 0=W/O Light Pipe | C=W/O Heatsink, Close Top |
| 1=W/Single Light Pipe(Round)DIM "A"=9.7mm | 1=W/PCI(Heatsink 4.2mm) |
| 2=W/Double Light Pipe(Round)DIM "A"=9.7mm | 2=W/SAN(Heatsink 6.5mm) |
| 5=W/Quad Light Pipe(Round)DIM "A"=9.7mm | 3=W/Networking(Heatsink 13.5mm) |
| 6=W/Single,Double OR Quad Light Pipe(Round) | 11.PACKAGE OPTION: |
| DIM "A"=10.7mm | A=Tray |
| 7.LIGHT PIPE DIM. OPTION: | 12.INSULATOR COLOR: |
| 0=W/O Light Pipe | 0=Non Function |
| 1=Ø2.67mm For Single Light Pipe | |
| 2=Ø2.67mm For Double Light Pipe | |
| A=Ø2.67mm For Quad Light Pipe | |

UNLESS OTHERWISE
SPECIFIED TOLERANCE

3 PLACE ±0.1
2 PLACE ±0.2
1 PLACE ±0.3
ANGULAR: X±2'



CHANT SINCERE CO.,LTD
TEL:886-02-86471251 FAX:886-02-86472962

SCALE: AS SHOWN UNIT: mm
DRAWN: EVA 11/23/2018
CHECKED:
APPROVED:

DRAWN NAME:
QSFP+ 28G CAGE 1X4 Through Bezel
2/13
PRODUCT NO. 902GEA4PXXC6XXA0
FILE NAME: 902GEA4PXXC61XA0(X8)

REV.	DESCRIPTION	DATE	SIZE	REV.
1			A4	C

BASE CAGE DETAILS

P/N: 902GEA4P00C6X0A0 SHOWN

NUMBER OF REAR LEGS PER PORT

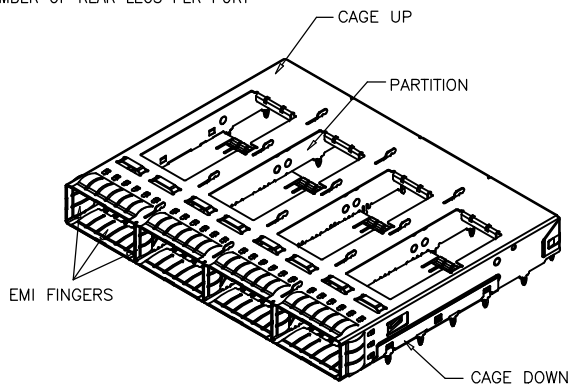
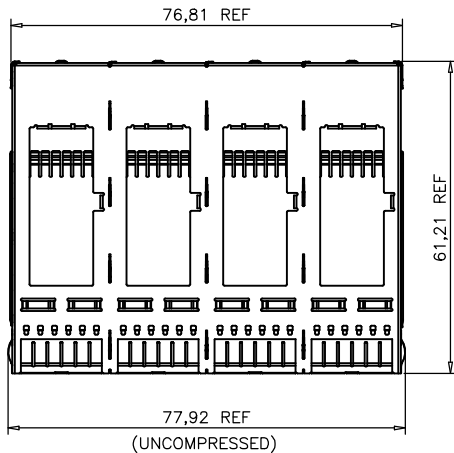

1. MATERIALS:

CAGE UP: STAINLESS STEEL, 0.25 THICKNESS
 CAGE DOWN: STAINLESS STEEL, 0.25 THICKNESS
 PARTITION: STAINLESS STEEL
 EMI FINGERS: STAINLESS STEEL
 HEATSINK: ALUMINUM
 HEATSINK CLIP: STAINLESS STEEL
 LIGHT PIPE MATERIAL: CLEAR POLYCARBONATE

2. SURFACE FINISH:

BODY CAGE: CLEANING
 EMI SPRING FINISH: CLEANING AND HOLE SEALING
 HEATSINK FINISH: BLACK ANODIZED
 HEATSINK CLIP FINISH: CLEANING

3. MATE WITH QSFP MSA COMPATIBLE TRANSCEIVER.

INSIDE SURFACE OF CASSET WHEN FULLY COMPRESSED.

5. REFERENCE DOCUMENTS:

PRODUCT SPECIFICATION: QSFP MSA

6. THIS PRODUCT COMPLY TO ROHS DIRECTIVE 2011/65/EU.

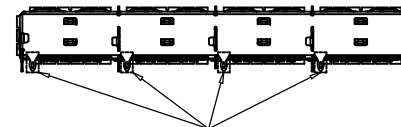
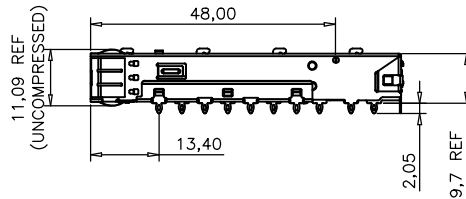
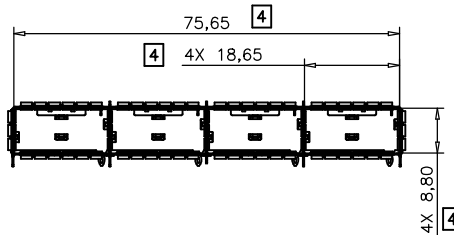

REAR LEGS ARE OPTIONAL:
 1 LEG OR NO LEG

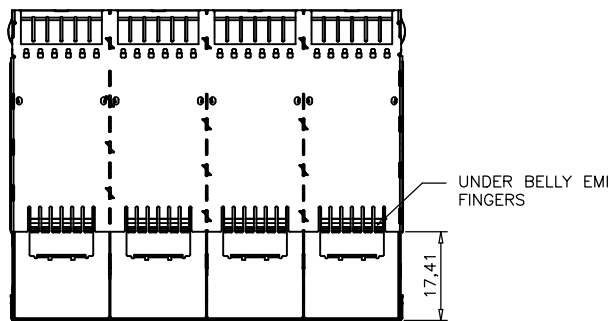

PART NUMBER SELECTION

NEXTRONICS P/N	REAR LEGS OPTIONALS
902GEA4P00C670A0	1 LEG PER PORT
902GEA4P00C610A0	0 LEG PER PORT

REAR LEGS OPTIONALS

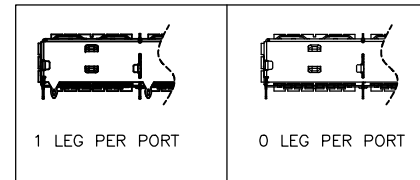

REMARK: APPLIES TO ALL CAGES IN THIS DRAWING

UNLESS OTHERWISE SPECIFIED TOLERANCE

3 PLACE ±0.1
 2 PLACE ±0.2
 1 PLACE ±0.3
 ANGULAR: X±2'



CHANT SINCERE CO.,LTD

TEL:886-02-86471251 FAX:886-02-86472962

SCALE: AS SHOWN

UNIT: mm

DRAWN: EVA

11/23/2018

CHECKED:

DRAWN NAME:
 QSFP+ 28G CAGE 1X4 Through Bezel
 3/13

APPROVED:

PRODUCT NO. 902GEA4PXXC6XXA0

REV.

DESCRIPTION

DATE

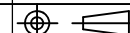

SIZE

A4

REV. C

FILE NAME:

902GEA4PXXC61XA0(X8)

CLOSED TOP, WITHOUT HEATSINK, WITHOUT LIGHT PIPE

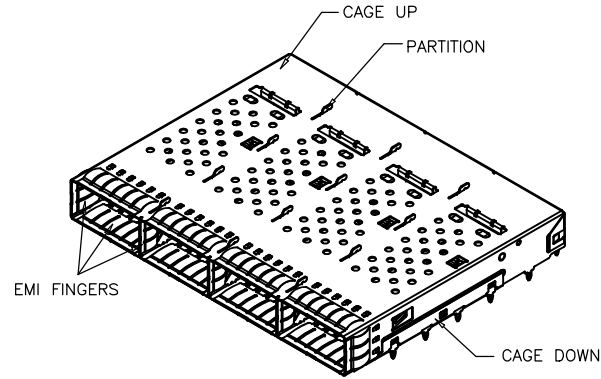
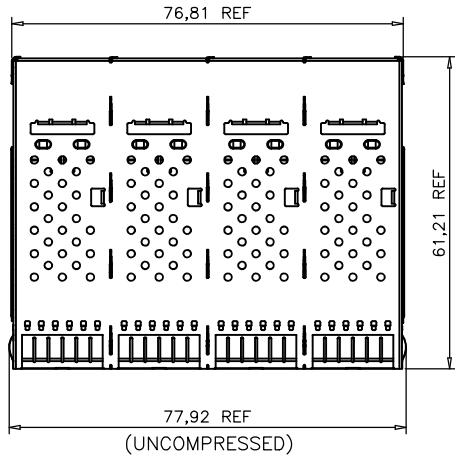

PART NUMBER SELECTION

NEXTRONICS P/N	REAR LEGS OPTIONALS
902GEA4P00C67CA0	1 LEG PER PORT
902GEA4P00C61CA0	0 LEG PER PORT

P/N: 902GEA4P00C6XCA0
NUMBER OF REAR LEGS PER PORT

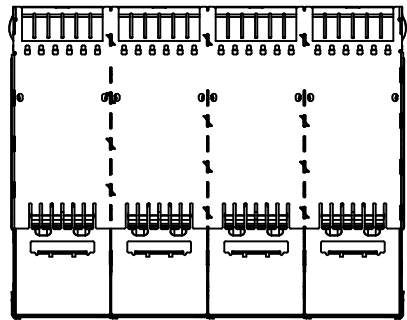
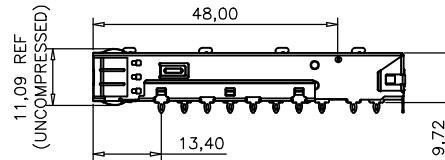

UNLESS OTHERWISE SPECIFIED TOLERANCE

- 3 PLACE ±0.1
- 2 PLACE ±0.2
- 1 PLACE ±0.3
- ANGULAR: X±2'

SCALE: AS SHOWN	UNIT: mm
DRAWN: EVA	11/23/2018
CHECKED:	
APPROVED:	



CHANT SINCERE CO.,LTD
TEL:886-02-86471251 FAX:886-02-86472962

DRAWN NAME: QSFP+ 28G CAGE 1X4 Through Bezel
4/13

PRODUCT NO. 902GEA4PXXC6XXA0

FILE NAME: 902GEA4PXXC61XA0(X8)

REV.	DESCRIPTION	DATE	SIZE	A4	REV.	C
1						
2						
3						
4						
5						
6						
7						
8						
9						
10						

WITHOUT HEATSINK, WITH LIGHT PIPES

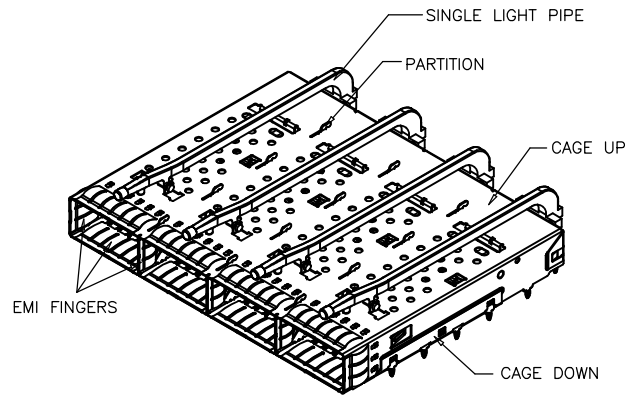
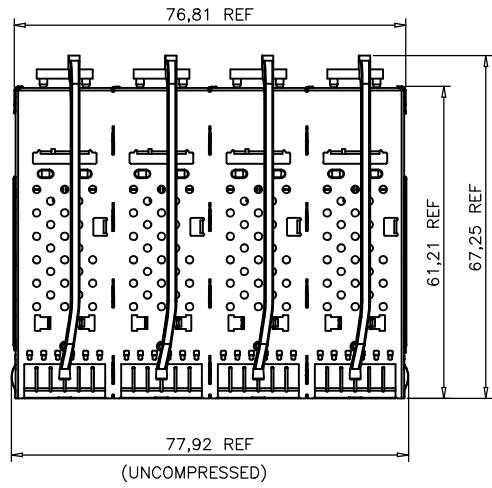

P/N: 902GEA4PX1C6XCA0
 LIGHT PIPE OPTION
 NUMBER OF REAR LEGS PER PORT

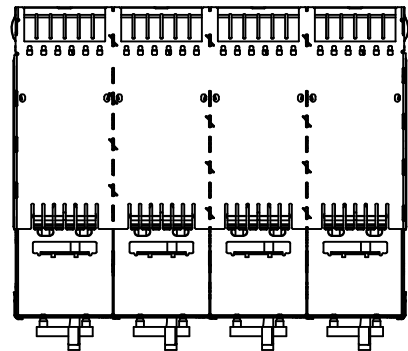
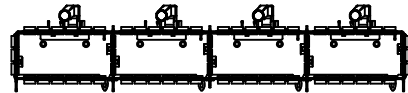
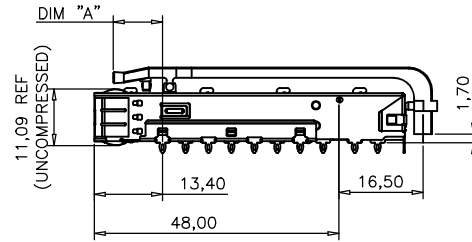

LIGHT PIPE OPTIONALS

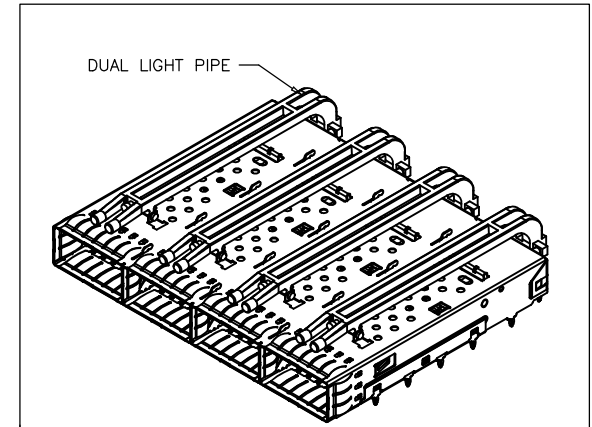

P/N: 902GEA4PX2C6XCA0
 LIGHT PIPE OPTION
 NUMBER OF REAR LEGS PER PORT

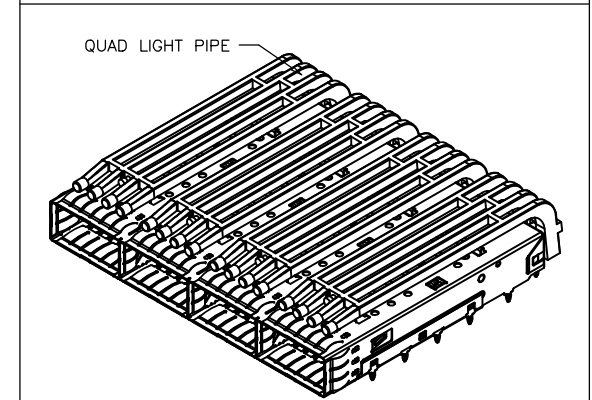

P/N: 902GEA4PXAC6XCA0
 LIGHT PIPE OPTION
 NUMBER OF REAR LEGS PER PORT

UNLESS OTHERWISE SPECIFIED TOLERANCE

- 3 PLACE ±0.1
- 2 PLACE ±0.2
- 1 PLACE ±0.3
- ANGULAR: X±2'

SCALE: AS SHOWN UNIT: mm

DRAWN: EVA 11/23/2018

CHECKED:

APPROVED:



CHANT SINCERE CO.,LTD
 TEL:886-02-86471251 FAX:886-02-86472962

DRAWN NAME:
 QSFP+ 28G CAGE 1X4 Through Bezel
 5/13

PRODUCT NO. 902GEA4PXXC6XXA0

FILE NAME: 902GEA4PXXC61XA0(X8)

REV.	DESCRIPTION	DATE	SIZE	REV.
1			A4	C

WITH HEATSINK, WITHOUT LIGHT PIPE

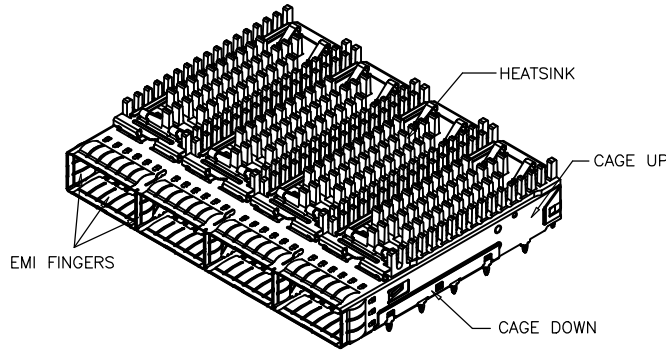
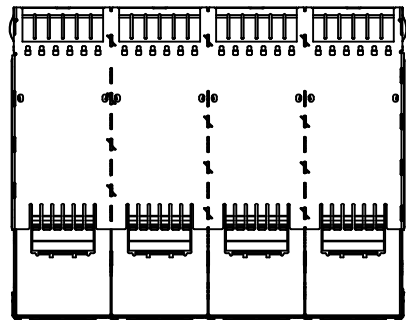
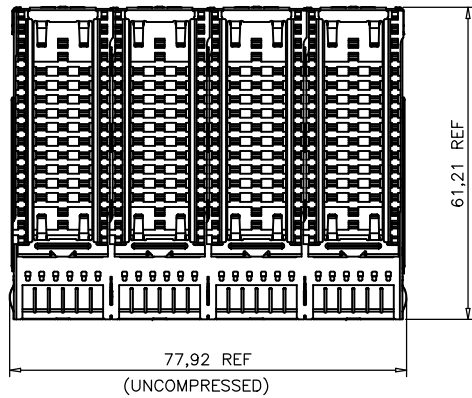

P/N: 902GEA4P00C6XXA0
 NUMBER OF REAR LEGS PER PORT
 HEATSINK

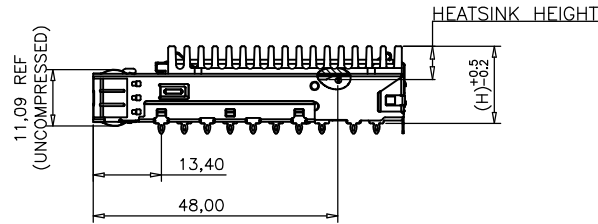

HEATSINK OPTIONALS

OVERALL HEATSINK HEIGHT	DIM "H"
PCI HS (4.2mm)	12.8
SAN HS (6.5mm)	15.1
NET HS (13.5mm)	22.1

REMARK: DIMENSION H ONLY APPLIES BEFORE MODULE INSTALLING INTO THE CAGE

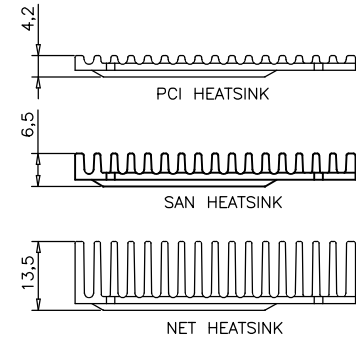

PART NUMBER SELECTION

NEXTRONICS P/N	HEATSINK	DIM "H"	REAR LEGS OPTIONALS
902GEA4P00C671A0	PCI	12.8mm	1 LEG
902GEA4P00C672A0	SAN	15.1mm	1 LEG
902GEA4P00C673A0	NET	22.1mm	1 LEG
902GEA4P00C611A0	PCI	12.8mm	0 LEG
902GEA4P00C612A0	SAN	15.1mm	0 LEG
902GEA4P00C613A0	NET	22.1mm	0 LEG

UNLESS OTHERWISE SPECIFIED TOLERANCE

- 3 PLACE ±0.1
- 2 PLACE ±0.2
- 1 PLACE ±0.3
- ANGULAR: X±2'

SCALE: AS SHOWN	UNIT: mm
DRAWN: EVA	11/23/2018
CHECKED:	
APPROVED:	



CHANT SINCERE CO.,LTD
 TEL:886-02-86471251 FAX:886-02-86472962

DRAWN NAME: QSFP+ 28G CAGE 1X4 Through Bezel
 6/13

PRODUCT NO. 902GEA4PXXC6XXA0

FILE NAME: 902GEA4PXXC61XA0(X8)

REV.	DESCRIPTION	DATE	SIZE	REV.	FILE NAME
1			A4	C	902GEA4PXXC61XA0(X8)

WITH HEATSINK, WITH LIGHT PIPES

LIGHT PIPE OPTIONALS

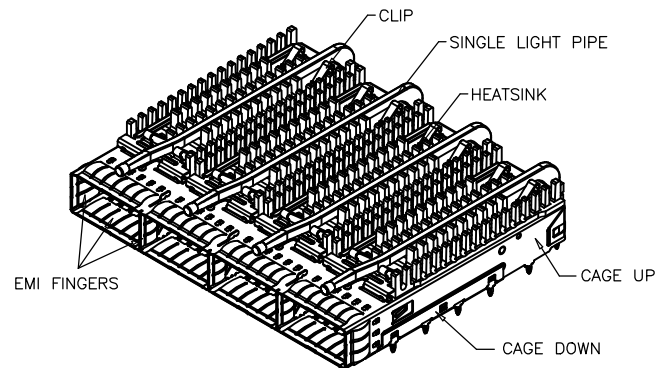
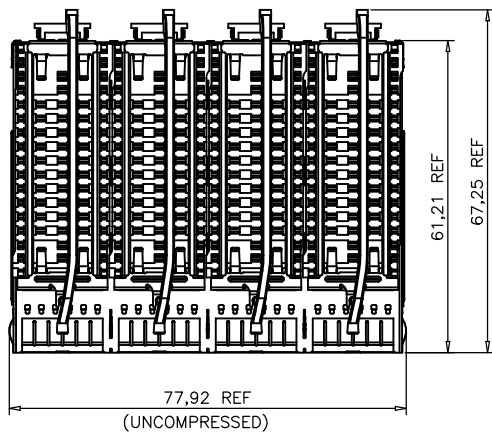

P/N: 902GEA4PX1C6XXA0
 LIGHT PIPE OPTION
 NUMBER OF REAR LEGS PER PORT
 HEATSINK

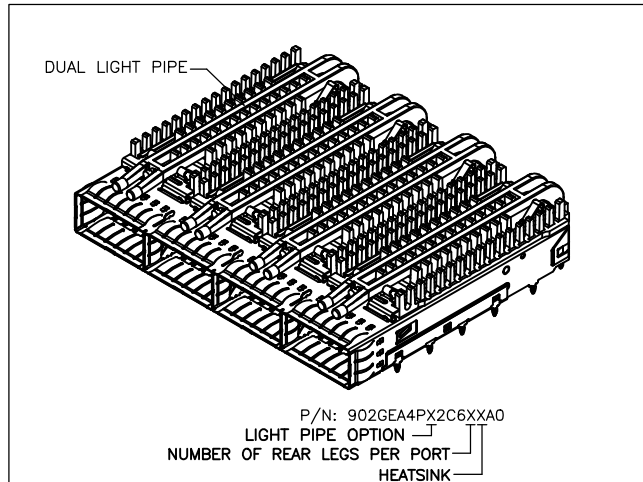

P/N: 902GEA4PX2C6XXA0
 LIGHT PIPE OPTION
 NUMBER OF REAR LEGS PER PORT
 HEATSINK

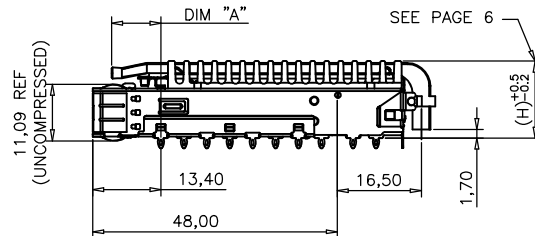

11,09 REF
(UNCOMPRESSED)

SEE PAGE 6

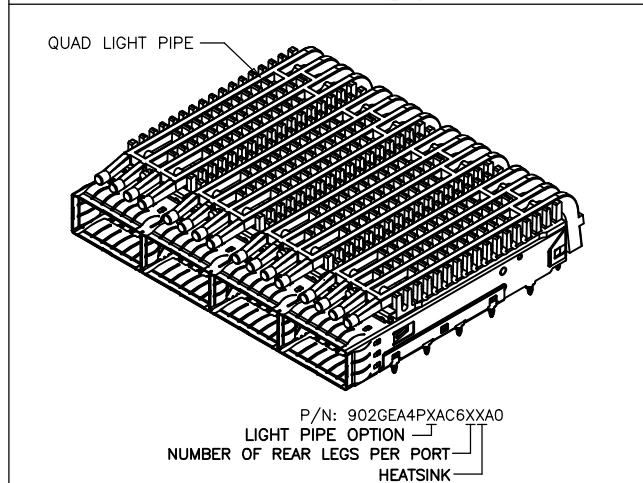

P/N: 902GEA4PXAC6XXA0
 LIGHT PIPE OPTION
 NUMBER OF REAR LEGS PER PORT
 HEATSINK

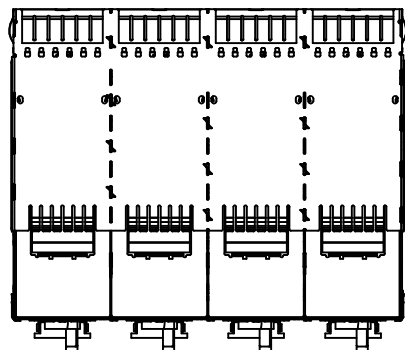

UNLESS OTHERWISE SPECIFIED TOLERANCE
 3 PLACE ±0.1
 2 PLACE ±0.2
 1 PLACE ±0.3
 ANGULAR: X±2'



CHANT SINCERE CO.,LTD
 TEL:886-02-86471251 FAX:886-02-86472962

SCALE: AS SHOWN UNIT: mm

DRAWN: EVA 11/23/2018

CHECKED:

APPROVED:

DRAWN NAME:
 QSFP+ 28G CAGE 1X4 Through Bezel
 7/13

PRODUCT NO. 902GEA4PXXC6XXA0

FILE NAME: 902GEA4PXXC61XA0(X8)

REV.	DESCRIPTION	DATE	SIZE	REV.
1			A4	C
2				
3				

PART NUMBER SELECTION

WITH HEATSINKS AND LIGHT PIPES

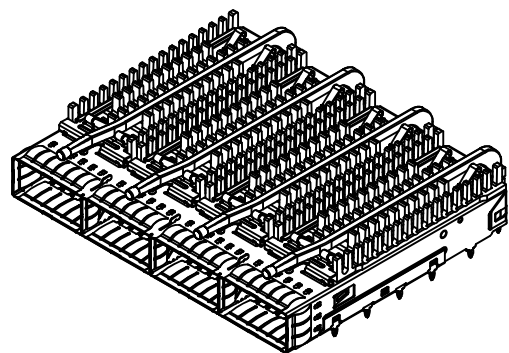

CLOSED TOP, WITH LIGHT PIPES

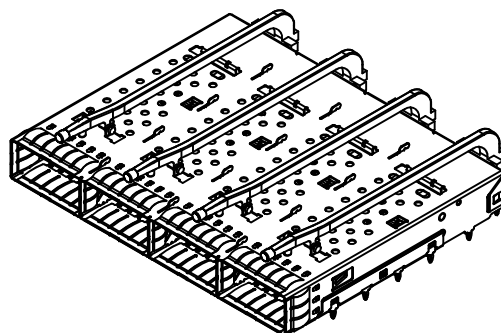

PART NUMBER SELECTION

NEXTRONICS P/N	HEATSINK	DIM "H"	LIGHT PIPES	DIM "A"	REAR LEGS
902GEA4P11C671A0	PCI	12.8mm	SINGLE	9.7mm	1 LEG
902GEA4P22C672A0	SAN	15.1mm	DUAL	9.7mm	1 LEG
902GEA4P5AC673A0	NET	22.1mm	QUAD	9.7mm	1 LEG
902GEA4P61C671A0	PCI	12.8mm	SINGLE	10.7mm	1 LEG
902GEA4P62C672A0	SAN	15.1mm	DUAL	10.7mm	1 LEG
902GEA4P6AC673A0	NET	22.1mm	QUAD	10.7mm	1 LEG
902GEA4P11C611A0	PCI	12.8mm	SINGLE	9.7mm	0 LEG
902GEA4P22C612A0	SAN	15.1mm	DUAL	9.7mm	0 LEG
902GEA4P5AC613A0	NET	22.1mm	QUAD	9.7mm	0 LEG
902GEA4P61C611A0	PCI	12.8mm	SINGLE	10.7mm	0 LEG
902GEA4P62C612A0	SAN	15.1mm	DUAL	10.7mm	0 LEG
902GEA4P6AC613A0	NET	22.1mm	QUAD	10.7mm	0 LEG

PART NUMBER SELECTION

NEXTRONICS P/N	LIGHT PIPES	DIM "A"	REAR LEGS
902GEA4P11C67CA0	SINGLE	9.7mm	1 LEG
902GEA4P11C61CA0	SINGLE	9.7mm	0 LEG
902GEA4P61C67CA0	SINGLE	10.7mm	1 LEG
902GEA4P61C61CA0	SINGLE	10.7mm	0 LEG
902GEA4P22C67CA0	DUAL	9.7mm	1 LEG
902GEA4P22C61CA0	DUAL	9.7mm	0 LEG
902GEA4P62C67CA0	DUAL	10.7mm	1 LEG
902GEA4P62C61CA0	DUAL	10.7mm	0 LEG
902GEA4P5AC67CA0	QUAD	9.7mm	1 LEG
902GEA4P5AC61CA0	QUAD	9.7mm	0 LEG
902GEA4P6AC67CA0	QUAD	10.7mm	1 LEG
902GEA4P6AC61CA0	QUAD	10.7mm	0 LEG

UNLESS OTHERWISE SPECIFIED TOLERANCE
 3 PLACE ±0.1
 2 PLACE ±0.2
 1 PLACE ±0.3
 ANGULAR: X±2'



CHANT SINCERE CO.,LTD
 TEL:886-02-86471251 FAX:886-02-86472962

SCALE: AS SHOWN	UNIT: mm
DRAWN: EVA	11/23/2018
CHECKED:	
APPROVED:	
DATE	SIZE A4
REV. C	

DRAWN NAME:	8/13
PRODUCT NO.	902GEA4PXXC6XXA0
FILE NAME:	902GEA4PXXC61XA0(X8)

REV.

DESCRIPTION

DATE

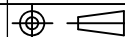

SIZE

A4

REV. C

FILE NAME:

902GEA4PXXC61XA0(X8)

BEZEL AND BOARD POSITION DIMENSION
FOR SINGLE SIDE MOUNTING (SPRING FINGER)

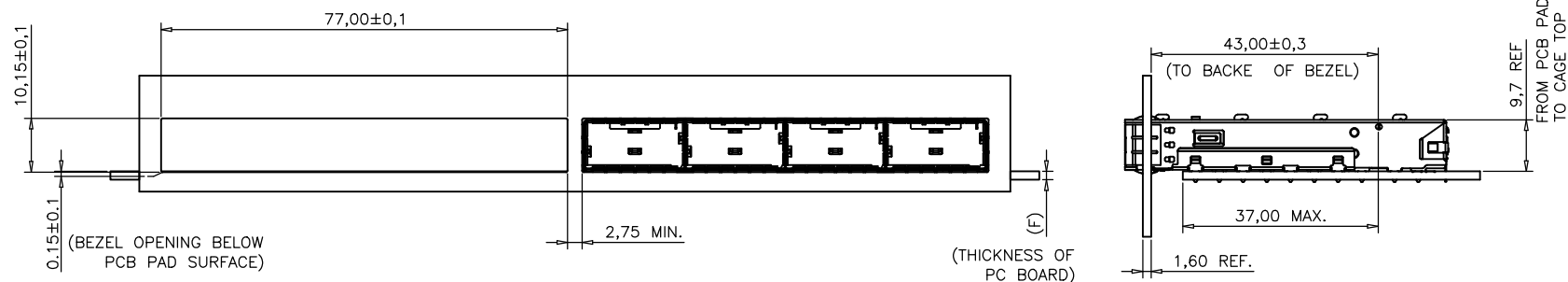

BEZEL AND BOARD POSITION DIMENSION
FOR BELLY TO BELLY MOUNTING (SPRING FINGER)

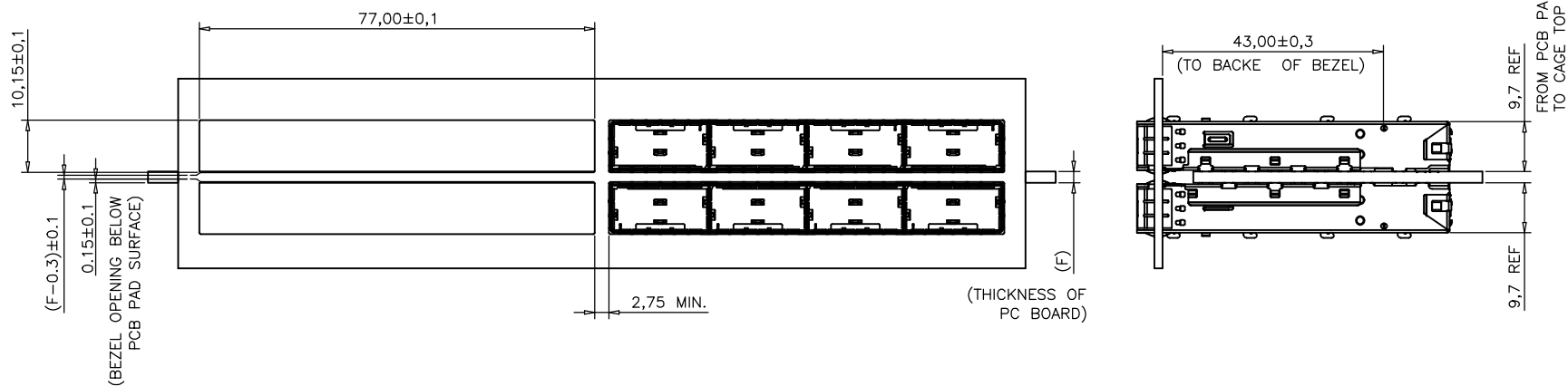

NOTES:

1. THE NORMAL THICKNESS OF CUSTOMER SUPPLIED PC BOARD.(DIM. "F")
SINGLE SIDED PC BOARD THICKNESS: 1.60mm MIN.
BELLY TO BELLY PC BOARD MIN. THICKNESS: 2.2mm MIN.

UNLESS OTHERWISE
SPECIFIED TOLERANCE

- 3 PLACE ±0.1
- 2 PLACE ±0.2
- 1 PLACE ±0.3
- ANGULAR: X±2'

SCALE: AS SHOWN

UNIT: mm

DRAWN: EVA

11/23/2018

CHECKED:

APPROVED:



CHANT SINCERE CO.,LTD

TEL:886-02-86471251 FAX:886-02-86472962

DRAWN NAME:
QSFP+ 28G CAGE 1X4 Through Bezel
9/13

PRODUCT NO. 902GEA4PXXC6XXA0

FILE NAME: 902GEA4PXXC61XA0(X8)

REV.

DESCRIPTION

DATE



SIZE

A4

REV. C

1

2

3

4

5

6

7

8

9

10

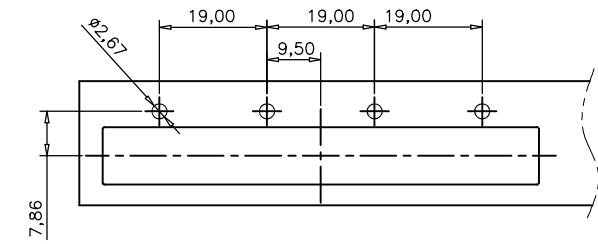

BEZEL L/P CUT-OUT POSITION DIMENSION FOR SINGLE SIDE MOUNTING (SPRING FINGER)

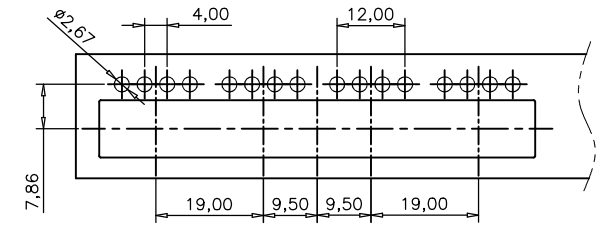
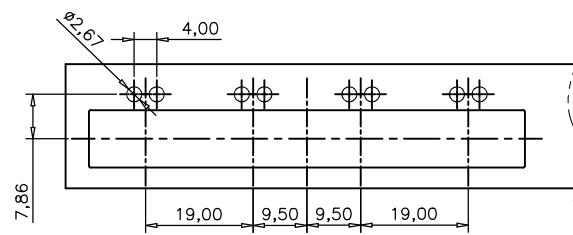

BEZEL L/P CUT-OUT POSITION DIMENSION FOR BELLY TO BELLY MOUNTING (SPRING FINGER)

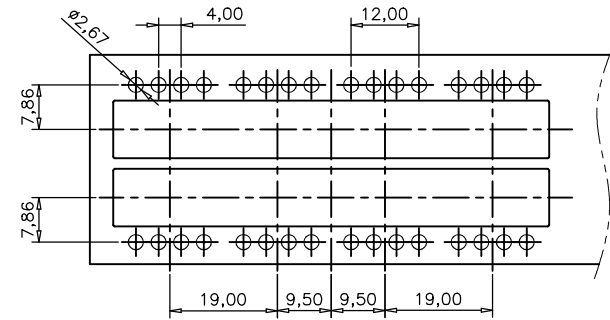
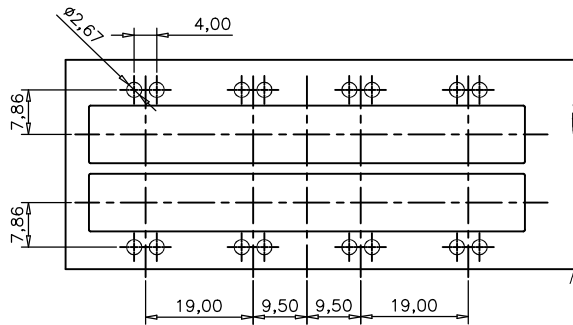
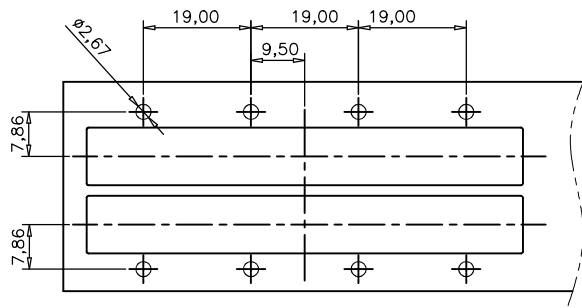

NOTE:
GENERAL TOLERANCE: ± 0.05 .

UNLESS OTHERWISE SPECIFIED TOLERANCE
3 PLACE ± 0.1
2 PLACE ± 0.2
1 PLACE ± 0.3
ANGULAR: $X \pm 2'$



SCALE: AS SHOWN UNIT: mm
DRAWN: EVA 11/23/2018
CHECKED:
APPROVED:

CHANT SINCERE CO.,LTD
TEL:886-02-86471251 FAX:886-02-86472962
DRAWN NAME:
QSFP+ 28G CAGE 1X4 Through Bezel
10/13

PRODUCT NO. 902GEA4PXXC6XXA0

REV.

DESCRIPTION

DATE

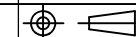



SIZE A4

REV. C

FILE NAME: 902GEA4PXXC61XA0(X8)

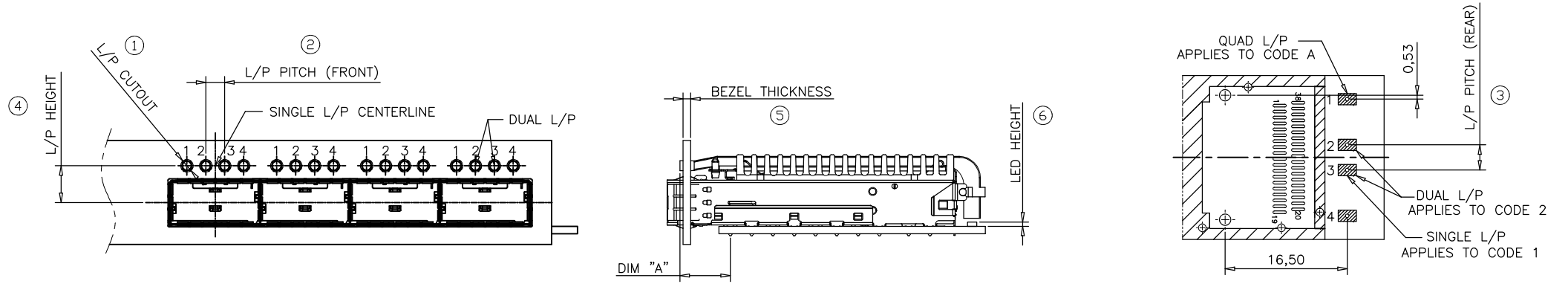
		THE DIMENSION FOR MATING BEZEL (UNIT: mm)						
CODE	L/P APPEARANCE	L/P CUT-OUT	L/P PITCH (FRONT)	L/P PITCH (REAR)	L/P HEIGHT	BEZEL THICKNESS	LED HEIGHT	REMARK
0	NO L/P							WITHOUT LIGHT PIPE
1	ROUND	φ2.67	SEE BELOW DRAWING	SEE BELOW DRAWING	7.86	1.60	0.8~1.1	APPLIES TO SINGLE L/P
2	ROUND	φ2.67	2,3=4.00	2,3=3.40	7.86	1.60	0.8~1.1	APPLIES TO DUAL L/P
A	ROUND	φ2.67	4.00(Equal)	1,4=15.75 2,3=3.40	7.86	1.60	0.8~1.1	APPLIES TO QUAD L/P
		①	②	③	④	⑤	⑥	



UNLESS OTHERWISE SPECIFIED TOLERANCE 3 PLACE ±0.1 2 PLACE ±0.2 1 PLACE ±0.3 ANGULAR: X±2'		 CHANT SINCERE CO.,LTD TEL:886-02-86471251 FAX:886-02-86472962	
SCALE: AS SHOWN	UNIT: mm		
DRAWN: EVA	11/23/2018	DRAWN NAME: QSFP+ 28G CAGE 1X4 Through Bezel 11/13	
CHECKED:		PRODUCT NO. 902GEA4PXXC6XXA0	
APPROVED:		FILE NAME: 902GEA4PXXC61XA0(X8)	

REV.	DESCRIPTION	DATE
1		
2		
3		
4		
5		
6		

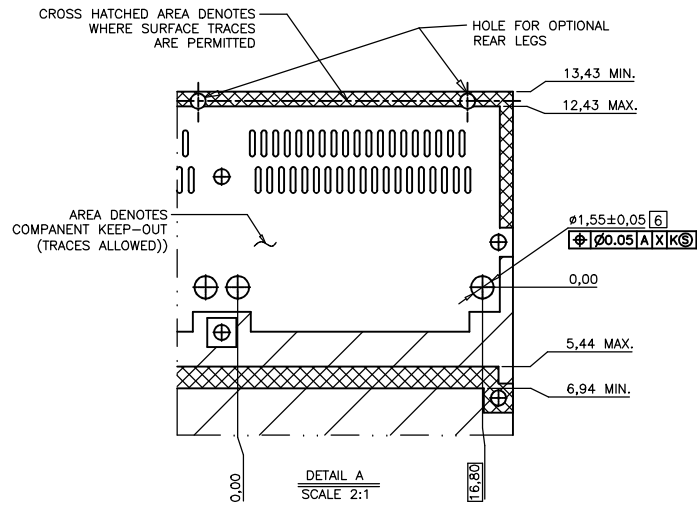
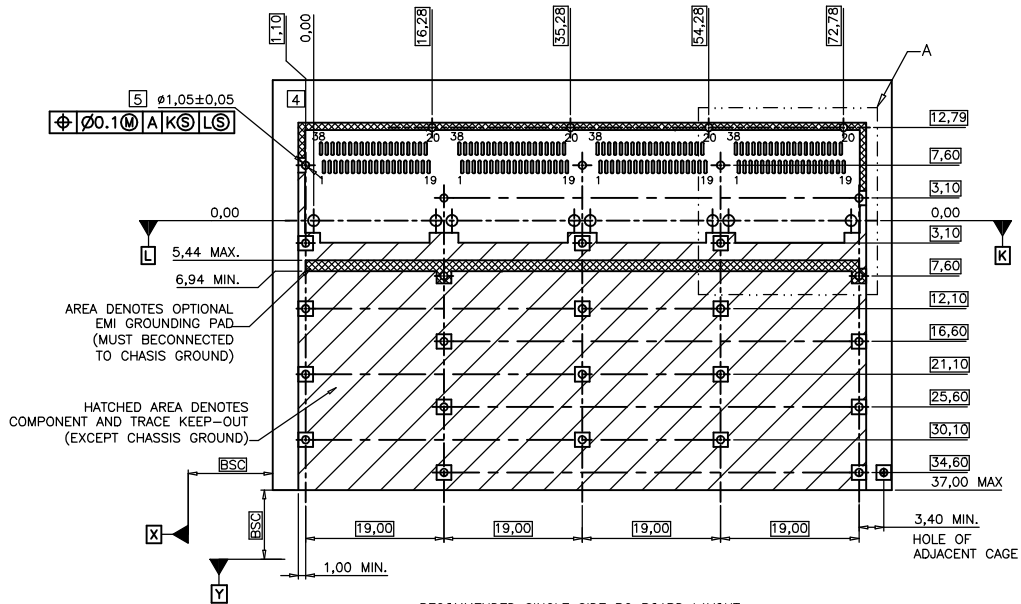

- NOTES:
1. DATUM X & Y ARE ESTABLISHED BY THE CUSTOMER'S FIDUCIAL
 2. DATUM A IS THE TOP SURFACE OF THE HOST BOARD
 3. LOCATION OF THE EDGE OF PCB IS APPLICATION SPECIFIC
 4. BASELINE FOR THESE DIMENSIONS IS THE CENTER OF COMPLIANT PIN HOLE.
 5. FINISHED HOLE SIZE
 6. UNPLATED THRU HOLE.
 7. REFER TO SFF8662 FOR CONNECTOR FOOTING DIMENSIONS

FOR CAGE ASSEMBLIES WITH LIGHT PIPES

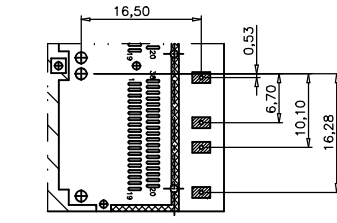
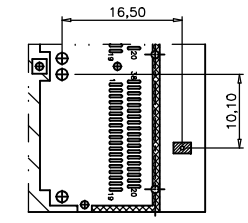
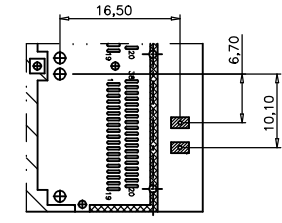

UNLESS OTHERWISE SPECIFIED TOLERANCE

3 PLACE ±0.1
2 PLACE ±0.2
1 PLACE ±0.3
ANGULAR: X±2'



CHANT SINCERE CO.,LTD
TEL:886-02-86471251 FAX:886-02-86472362

SCALE: AS SHOWN UNIT: mm
DRAWN: EVA 11/23/2018
CHECKED:
APPROVED:

DRAWN NAME: QSFP+ 28G CAGE 1X4 Through Bezel 12/13
PRODUCT NO. 902GEA4PXXC6XXA0

REV.	DESCRIPTION	DATE	SIZE	REV.	FILE NAME:
1			A4	C	902GEA4PXXC61XA0(X8)

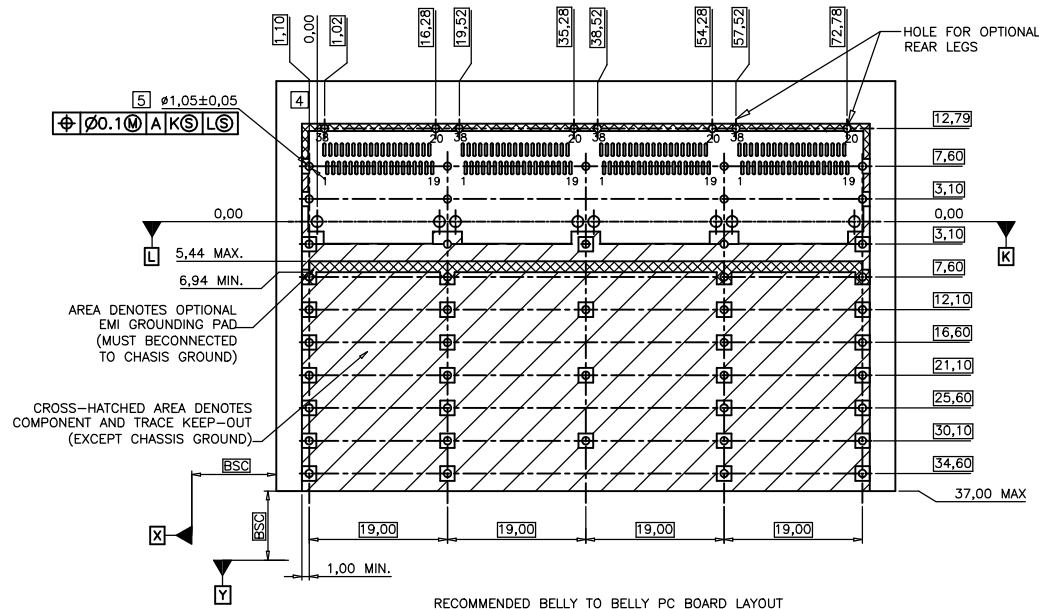

RECOMMENDED BELLY TO BELLY PC BOARD LAYOUT

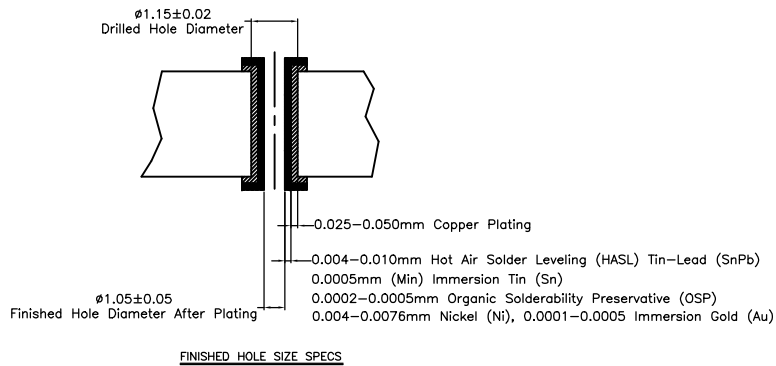

FINISHED HOLE SIZE SPECS

UNLESS OTHERWISE SPECIFIED TOLERANCE		 CHANT SINCERE CO.,LTD TEL:886-02-86471251 FAX:886-02-86472962
SCALE: AS SHOWN	UNIT: mm	
DRAWN: EVA	11/23/2018	DRAWN NAME: QSFP+ 28G CAGE 1X4 Through Bezel 13/13
CHECKED:		PRODUCT NO. 902GEA4PXXC6XXA0
APPROVED:		FILE NAME: 902GEA4PXXC61XA0(X8)

REV.	DESCRIPTION	DATE	SIZE	REV.
1			A4	C