

SPECIFICATION

MATERIAL

Insulator: PA9T
 Contacts: Brass
 Outer Contacts: Zinc Alloy
 Contact Plating
 Contact area: 6u" Selective gold
 Solder tails area: 120u"~240u" Tin (Lead Free)
 Outer Contacts Plating
 Underplate: 120u"~240u" Tin (Matte) over 120u"~240u" Nickel over 240~480u" Cu

ELECTRICAL

Impedance, differential mode: 100 Ω differential signalling, for one pair or quad cable shielded
 Frequency: DC to 2.0 GHz
 Return loss: ≥ 20 dB to 1.0 GHz
 ≥ 17 dB to 2.0 GHz

Insertion loss: ≤ 0.1 dB @ 1.0 GHz

Insulation resistance: ≥ 1000MΩ
 Signal contact resistance: ≤ 10mΩ

MECHANICAL

Mating Cycles: ≥ 25 Cycles
 Engagement force: ≤ 30N
 Disengagement force: ≥ 5N
 Retention force latch: ≥ 110N
 Coding efficiency: ≥ 80N
 Temperature range: -40°C TO +105°C

Part no.

410 A F D1 N 6 T P1 T 1 C X
 1 2 3 4 5 6 7 8 9 10 11 12

1.SERIES NO.

410=Auto Movetive

2.A=DIP Type

3.GREEN OPTION:

F=RoHS (Matte)

4.CONTACT NUMBER:

D1=HSD+8Pin MQS

5.CONTACT TYPE:

N=MALE

6.CONTACT AREA PLATING:

6=6u" GOLD

7.SOLDER TAILS AREA PLATING:

T=120u"~240u" Tin(Lead Free)

8.APPLY TYPE:

P1=Right Angle Type

9.SHELL PLATING:

T=Tin

10.1=Standard

11.PACKING STYLE:

C=TAPE REEL

12.CODING COLOR & CODING TYPE:

A=GRAPHITE BLACK

B=NATURAL

C=LIGHT BLUE

D=CLARET VIOLET

Z=WATER BLUE

| | |
|--------------------------------------|-------|
| UNLESS OTHERWISE SPECIFIED TOLERANCE | |
| ANG. | +5° |
| 0. | ±0.50 |
| .0 | ±0.30 |
| .00 | ±0.20 |

| | |
|-----------------|----------|
| SCALE: AS SHOWN | UNIT: mm |
|-----------------|----------|

| | |
|-------------|----------|
| DRAWN JERRY | 01/22/20 |
|-------------|----------|

| | |
|---------|--|
| CHECKED | |
|---------|--|

| | |
|----------|--|
| APPROVED | |
|----------|--|

| | |
|---------|---------|
| SIZE A4 | REV. X1 |
|---------|---------|



CHANT SINCERE CO.,LTD

TEL:886-02-86471251 FAX:886-02-86472962

Title:
HSD Right Angle Plug for PCB with MQS Contacts 1/3

Part NO. 410AFD1N6TP1T1CX

Code: Customer:

| | | | |
|------|----------|-------------|------|
| Zone | Revision | Description | Date |
| 1 | 2 | 3 | 4 |

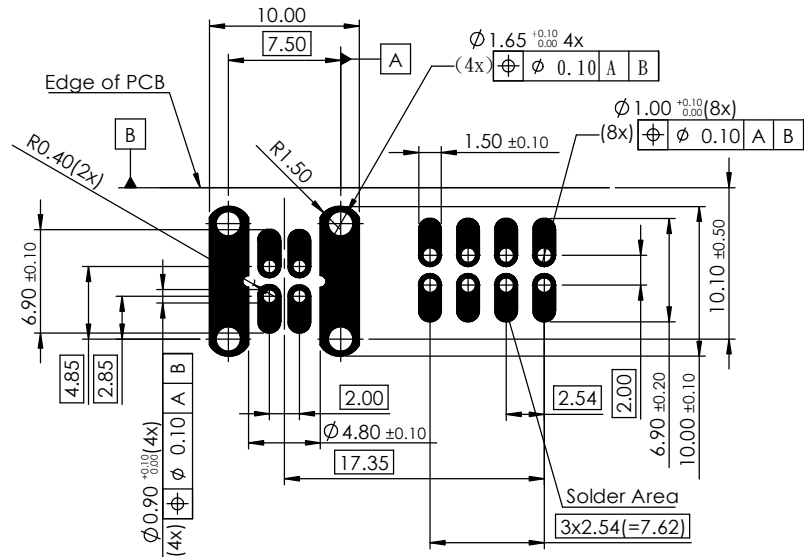
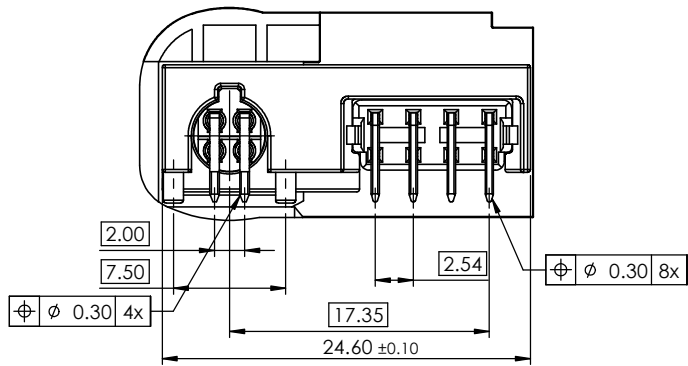

RECOMMENDED. P.C.B LAYOUT
 TOLERANCERS: ± 0.02 mm

| | |
|--------------------------------------|---------------|
| UNLESS OTHERWISE SPECIFIED TOLERANCE | |
| ANG. | $\pm 5^\circ$ |
| 0. | ± 0.50 |
| .0 | ± 0.30 |
| .00 | ± 0.20 |

SCALE: AS SHOWN UNIT: mm

DRAWN JERRY 01/22/20

CHECKED

APPROVED

SIZE A4 REV. X1





CHANT SINCERE CO.,LTD
 TEL:886-02-86471251 FAX:886-02-86472962

Title:
 HSD Right Angle Plug for PCB with MQS Contacts 2/3

Part NO. 410AFD1N6TP1T1CX

Code: Customer:

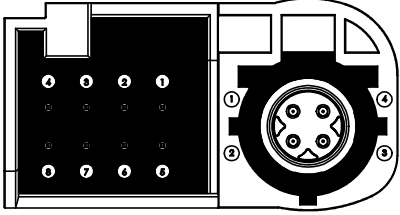
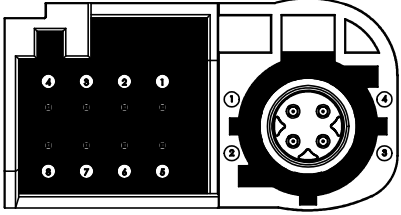
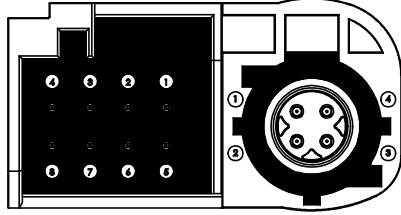
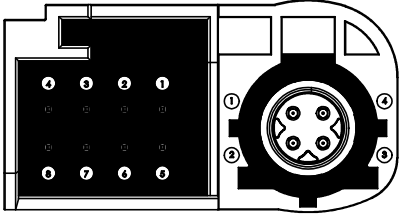
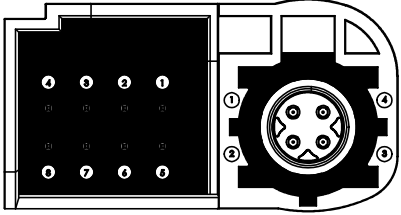
| Zone | Revision | Description | Date |
|------|----------|-------------|------|
| 1 | 2 | 3 | 4 |
| 5 | 6 | 7 | 8 |
| 9 | 10 | | |

| CODINGS | | | | | | | | | | | | | | | | | |
|--|--|---|---|---|---|---|---|---------|--|-----------|----|-------|-----|-------|---|--|--|
| Coding | A | | | B | | | C | | | | | | | | | | |
| Plug |  | | |  | | |  | | | | | | | | | | |
| Color | Graphite Black | | | Natural | | | Light Blue | | | | | | | | | | |
| RAL | sim. 9011 | | | sim. 9001 | | | sim. 5012 | | | | | | | | | | |
| Coding | D | | | Z Z | | | | | | | | | | | | | |
| Plug |  | | |  | | | | | | | | | | | | | |
| Color | Claret Violet | | | Water Blue | | | | | | | | | | | | | |
| RAL | sim. 4004 | | | sim. 5021 | | | | | | | | | | | | | |
| <p>UNLESS OTHERWISE SPECIFIED TOLERANCE</p> <table border="1"> <tr> <td>ANG.</td> <td>±5°</td> </tr> <tr> <td>0.</td> <td>±0.50</td> </tr> <tr> <td>.0</td> <td>±0.30</td> </tr> <tr> <td>.00</td> <td>±0.20</td> </tr> </table> | | | | | | | ANG. | ±5° | 0. | ±0.50 | .0 | ±0.30 | .00 | ±0.20 |  CHANT SINCERE CO.,LTD <small>TEL:886-02-86471251 FAX:886-02-86472962</small> | | |
| ANG. | ±5° | | | | | | | | | | | | | | | | |
| 0. | ±0.50 | | | | | | | | | | | | | | | | |
| .0 | ±0.30 | | | | | | | | | | | | | | | | |
| .00 | ±0.20 | | | | | | | | | | | | | | | | |
| SCALE: AS SHOWN | | | | | | | UNIT: mm | | Title: | | | | | | | | |
| DRAWN: JERRY | | | | | | | 01/22/20 | | HSD Right Angle Plug for PCB with MQS Contacts | | | | | | | | |
| CHECKED: | | | | | | | | | 3/3 | | | | | | | | |
| APPROVED: | | | | | | | | | Part NO. 410AFD1N6TP1T1CX | | | | | | | | |
| Zone | | | | | | | SIZE A4 | REV. X1 | Code: | Customer: | | | | | | | |
| 1 | 2 | 3 | 4 | 5 | 6 | 7 | 8 | 9 | 10 | | | | | | | | |