

Platinenkante edge of PCB
 RECOMMENDED P.C.B. LAYOUT
 TOLERANCE: ±0.05mm

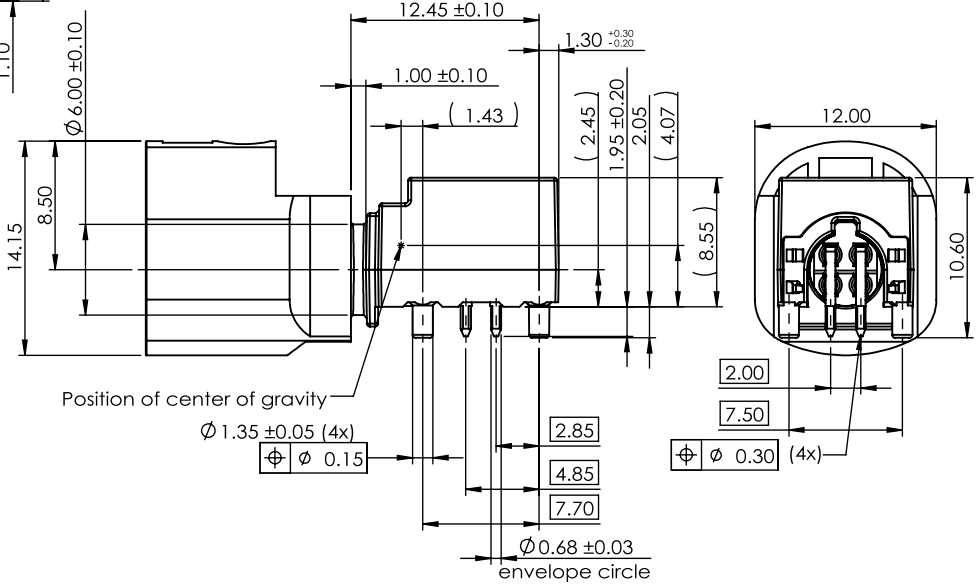
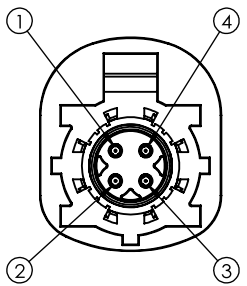

Position of center of gravity

SPECIFICATION
MATERIAL
 Insulator: PA9T
 Contacts: Brass
 Outer Contacts: Zinc Alloy
 Contact Plating
 Contact area: 6u" Selective gold
 Solder tails area: 120u"~240u" Tin (Lead Free)
 Outer Contact Plating:
 Underplate: 120u"~240u" Tin (Matte) over 120u"~240u" Nickel over 600u"~800u" Cu
ELECTRICAL
 Impedance, differential mode: 100 Ω differential signalling, for one pair or quad cable shielded
 Frequency: DC to 2.0 GHz
 Return loss: ≥ 20 dB to 1.0 GHz
 ≥ 17 dB to 2.0 GHz
 Insertion loss: ≤ 0.1 dB @ 1.0 GHz
 Insulation resistance: ≥ 1000MΩ
 Signal contact resistance: ≤ 10mΩ
MECHANICAL
 Mating Cycles: ≥ 25 Cycles
 Engagement force: ≤ 30N
 Disengagement force: ≥ 5N
 Retention force latch: ≥ 110 N
 Coding efficiency: ≥ 80N
 Temperature range: -40°C TO +105°C
 Part no. 410 A F 04 N 6 T S1 4 X C X
 1 2 3 4 5 6 7 8 9 10 11 12

- 1.SERIES NO.
410=HSD
- 2.A=DIP Type
- 3.GREEN OPTION:
F=RoHS (Matte)
- 4.CONTACT NUMBER:
04=04 PINS
- 5.CONTACT TYPE:
N=MALE
- 6.CONTACT AREA PLATING:
6= 6u" Gold
- 7.SOLDER TAILS AREA PLATING:
T=120u"~240u" Tin (Lead Free)
- 8.APPLY TYPE:
S1=Right Angle Type
- 9.SHELL PLATING:
4=Tin+Rib(Shell Height=8.55mm)
10.1=Standard
2=Reverse
- 11.PACKING STYLE:
C=TAPE & REEL
- 12.CODING COLOR & CODING TYPE:
A=BLACK
B=WHITE
C=BLUE
D=BORDEAUX
E=GREEN
F=BROWN
G=BLUE GREY
H=HEATHER VIOLET
J=BEIGE
K=CURRY
L=YELLOW GREEN
M=PASTEL ORANGE
O=LIGHT GREEN
Z=WATER BLUE

UNLESS OTHERWISE SPECIFIED TOLERANCE	
ANG.	±5°
0.	±0.50
.0	±0.30
.00	±0.20
SCALE: AS SHOWN	UNIT: mm
DRAWN Bill_hsu	14/02/2020
CHECKED Jerry_Chou	18/02/2020
APPROVED Mark	18/02/2020
SIZE A4	REV. x2

OXOC

CHANT SINCERE CO.,LTD
 TEL:886-02-86471251 FAX:886-02-86472962

Title:
FAKRA HSD R/A Plug
 (Shell Height=8.55mm)

1/3

Part NO. 410AF04N6TS14XCX
 Factory: GC Customer:



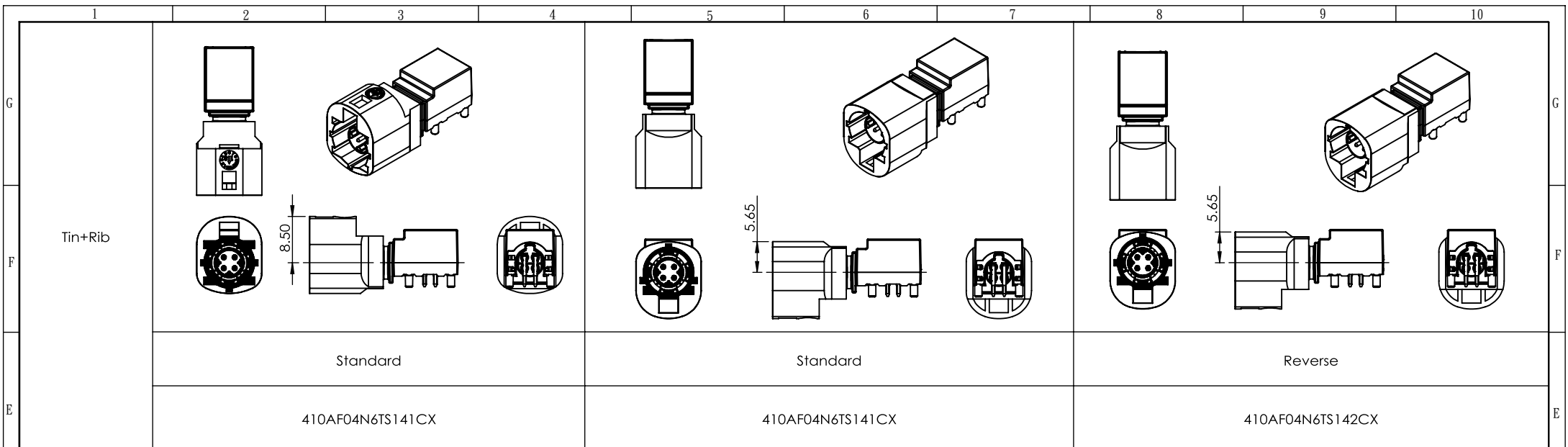















Zone	Revision	Description	Date
1	2	3	4
5	6	7	8
9	10		





D											D
C											C
B											B
A											A

UNLESS OTHERWISE SPECIFIED TOLERANCE		 CHANT SINCERE CO.,LTD TEL:886-02-86471251 FAX:886-02-86472962		
ANG.	±5°			
0.	±0.50			
.0	±0.30			
.00	±0.20	SCALE: AS SHOWN	UNIT: mm	
DRAWN	Bill_hsu	14/02/2020	Title: FAKRA HSD R/A Plug (Shell Height=8.55mm) 2/3	
CHECKED	Jerry_Chou	18/02/2020		
APPROVED	Mark	18/02/2020	Part NO. 410AF04N6TS14XCX	
		SIZE A4	REV. X2	Factory: GC Customer:

Zone	Revision	Description				Date				
1	2	3	4	5	6	7	8	9	10	

	1	2	3	4	5	6	7	8	9	10
	CODINGS 1 : 1									
G	Coding	A	B	C	D	E	F	Z		
	Plug									
	Color	Black	White	Blue	Bordeaux	Green	Brown	Water Blue		
F	RAL	sim.9005	sim.9001	sim.5005	sim.4004	sim.6002	sim.8001	sim.5021		
	Coding	G	H	J	K	L	M	O		
E	Plug									
	Color	Blue Grey	Heather Violet	Beige	Curry	Yellow Green	Pastel Orange	Light Green		
	RAL	sim.7031	sim.4003	sim.1001	sim.1027	sim.6018	sim.2003	sim.6027		
D	Coding	A Reverse	B Reverse	C Reverse	D Reverse					
	Plug									
C	Color	Black	White	Blue	Bordeaux					
	RAL	sim.9005	sim.9001	sim.5005	sim.4004					

UNLESS OTHERWISE SPECIFIED TOLERANCE		 CHANT SINCERE CO.,LTD TEL:886-02-86471251 FAX:886-02-86472962	
ANG.	±5°		
0.	±0.50	Title: FAKRA HSD R/A Plug (Shell Height=8.55mm)	
.0	±0.30		
.00	±0.20		
SCALE:	AS SHOWN	UNIT:	mm
DRAWN	Bill_hsu	14/02/2020	Part NO. 410AF04N6TS14XCX Factory: GC Customer:
CHECKED	Jerry_Chou	18/02/2020	
APPROVED	Mark	18/02/2020	
  SIZE A4		REV.	x2

Zone	Revision	Description	Date
1	2	3	4