

NOTES:

- ELECTRICAL CHARACTERISTICS:
 - CONTACT CURRENT RATING:
 - 2.0 A FOR VBUS PIN AND ITS CORRESPONDING GND PIN.
 - 0.25 A MIN FOR ALL OTHER CONTACTS.
 - CONTACT RESISTANCE:
 - 30 MILLIOHMS MAX FOR VBUS AND GND CONTACTS.
 - 50 MILLIOHMS MAX FOR ALL OTHER CONTACTS.
 - DIELECTRIC WITHSTANDING VOLTAGE: 100 VRMS AC MIN.
 - INSULATION RESISTANCE: 100 MEGOHMS MIN.
- MECHANICAL CHARACTERISTICS:
 - CONNECTOR INSERTION FORCE: 35N MAX.
 - CONNECTOR EXTRACTION FORCE: 10N MIN INITIAL, 8N MIN AFTER DURABILITY.
 - DURABILITY: 5000 CYCLES.
 - OPERATING TEMPERATURE: -55°C TO +85°C
- DIMENSIONS ARE IN MILLIMETERS, BRACKETED DIMENSIONS ARE INCHES EQUIVALENTS.
- RECOMMENDED PROCESS: WAVE SOLDER 260°C, 3-5SECONDS.
- THE CONNECTOR IS ROHS COMPLIANT AND HALOGEN FREE COMPLIANT.

377 A X 36 F X T S F N X A X
1 2 3 4 5 6 7 8 9 101112

- | | |
|--|--|
| 1.SERIES NO.
377=USB Series 3.0 | 7.SOLDER TAILS AREA PLATING
SELECTIVE PLATING
T= TIN |
| 2.TYPE
A=STANDARD | 8.APPLY TYPE:
SF=4 PORT |
| 3.GREEN OPTION:
E=RoHS(Bright)
G=RoHS(Bright)(Halogen Free) | 9.SHELL PLATING:
N=Nickel |
| 4.CONTACT NUMBER:
36=09*4 PIN | 10.TYPE OPTION:
0=Standard(U2/U3 Brass)PBT
3=Standard(U2 Ph/U3 Brass)PBT
4=Standard(U2/U3 Brass)HTN |
| 5.CONTACT TYPE:
F=FEMALE | 11.PACKING OPTION:
A=TRAY
2=Blue
3=Black
B=Blue+Date Code
C=Black+Date Code |
| 6.CONTACT AREA PLATING:
S= GOLD FLASH
C= 15u" GOLD
D= 30u" GOLD | 12.INSULATOR COLOR:
2=Blue
3=Black
B=Blue+Date Code
C=Black+Date Code |

PIN ASSIGNMENT:

Pin No.	D1	D2	D3	D4	D5	D6	D7	D8	D9
Pin No.	C1	C2	C3	C4	C5	C6	C7	C8	C9
Pin No.	B1	B2	B3	B4	B5	B6	B7	B8	B9
Pin No.	A1	A2	A3	A4	A5	A6	A7	A8	A9
Signal Name	VBUS	D-	D+	GND	STDA_SSRX-	STDA_SSRX+	GND_DRAIN	STDA_SSTX-	STDA_SSTX+

Remark	USB2 Contact Pin	USB3 Contact Pin	TREATMENT	
9	SPACER #2	1 PA66 UL 94V-0	MOLDED COLOR:BLACK HF OR NON HF	
8	SPACER #1	1 PA66 UL 94V-0	MOLDED COLOR:BLACK HF OR NON HF	
7	REAR SHELL	1 STAINLESS STEEL	CLEAN	
6	FINGER	3 STAINLESS STEEL	CLEAN	
5	FRAME	1 PBT UL 94V-0	MOLDED COLOR:BLACK HF OR NON HF	
4	U2 CONTACT	16 Phosphor Bronze or Brass	1~30u" MIN. Au PLATING AT CONTACT AREA. Lead free 100~200u" tin alloy at termination, Nickel 50~100u" underplating over all.	
3	U3 CONTACT	20 Brass		
2	INNER INSULATOR	4 PBT or HTN UL 94V-0	MOLDED COLOR: Black or Blue(PANTONE:300C) HF OR NON HF	
1	FRONT SHELL	1 STAINLESS STEEL	NI PLATED OVER ALL, TIN ALLOY(LEAD FREE) PLATED AT KINK AND TAB.	
NO.	DESCRIPTION	QTY.	MATERIAL	TREATMENT

UNLESS OTHERWISE SPECIFIED TOLERANCE
ANG. ± 3°
.0 ± 0.35
.00 ± 0.25
.000 ± 0.15



CHANT SINCERE CO.,LTD
TEL:886-02-86471251 FAX:886-02-86472962

SCALE: AS SHOWN UNIT: mm
DRAWN: PEARL 05/04/2016
CHECKED
APPROVED

DRAWN NAME:
QUADRUPLE STACKED
USB 3.0 A TYPE CONNECTOR 1/3
PRODUCT NO. 377AX36FXTSFXAX
FILE NAME: 377AX36FXTSFXAB(A07)

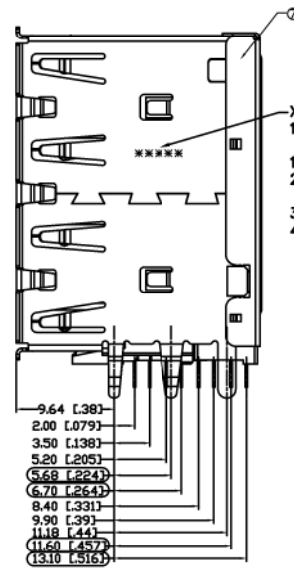
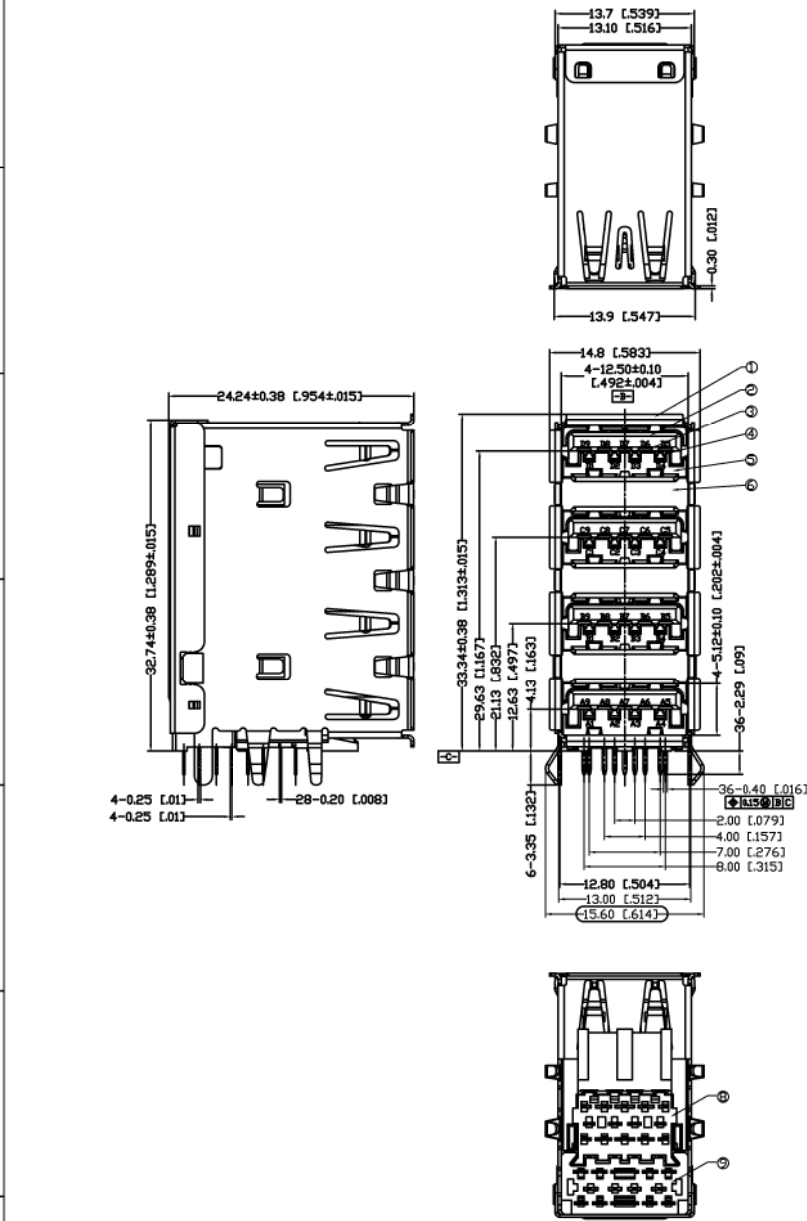

- Factory code
- Year
ex:5=2015
- Week code
- Running line

For SIP
For cmk/cpk

REV.	DESCRIPTION	DATE	SIZE	REV.	FILE NAME
1			A4	X3	377AX36FXTSFXAB(A07)

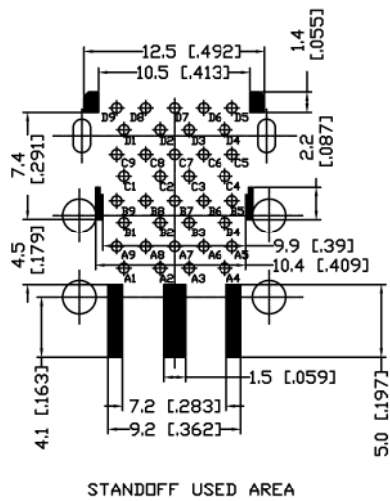
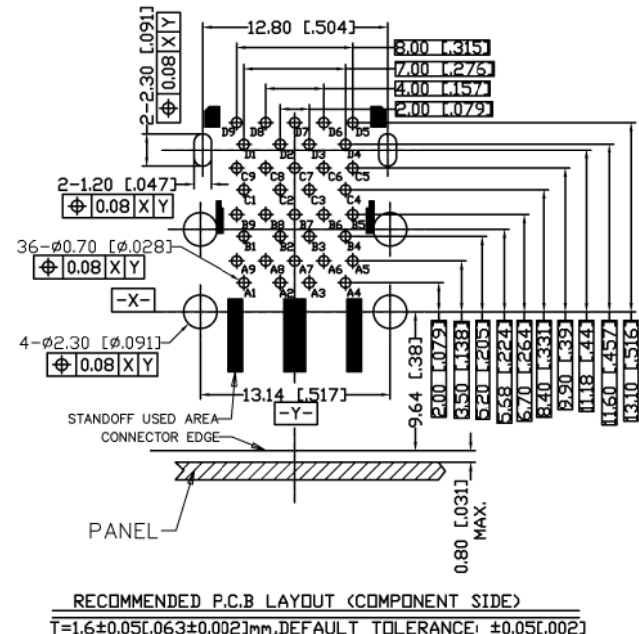
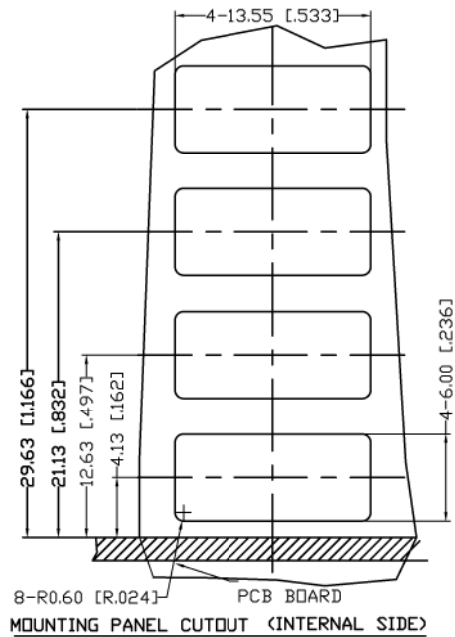
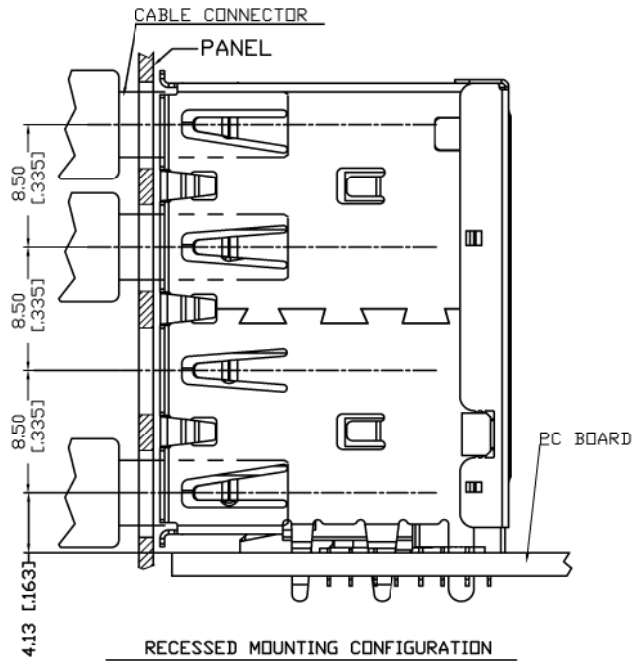

UNLESS OTHERWISE SPECIFIED TOLERANCE	
ANG.	± 3°
.0	± 0.35
.00	± 0.25
.000	± 0.15

SCALE: AS SHOWN	UNIT: mm
DRAWN: PEARL	DATE: 05/04/2016
CHECKED:	
APPROVED:	



CHANT SINCERE CO.,LTD
TEL:886-02-86471251 FAX:886-02-86472962

DRAWN NAME:	2/3
QUADRUPLE STACKED USB 3.0 A TYPE CONNECTOR	
PRODUCT NO.	377AX36FXTSFNXAX
FILE NAME:	377AX36FXTSFNXAB(A07)

REV.	DESCRIPTION	DATE	SIZE	REV.
			A4	X3

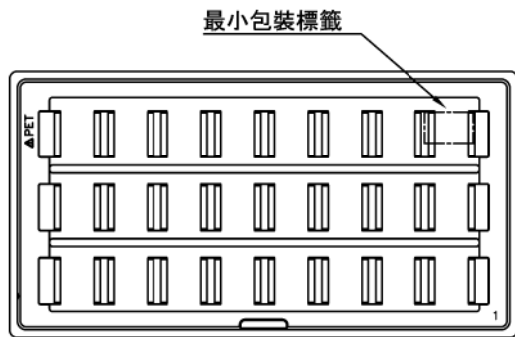

圖一

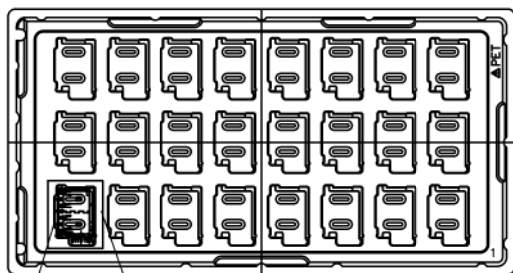

圖二

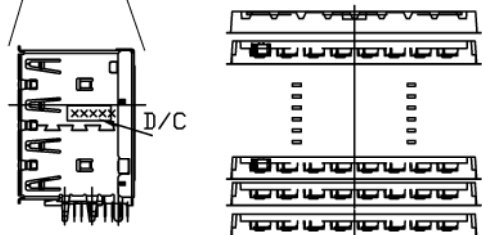

圖三

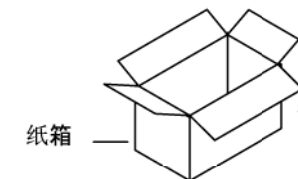
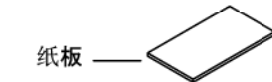
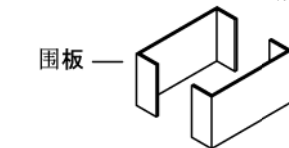
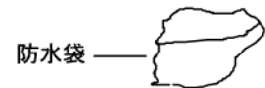
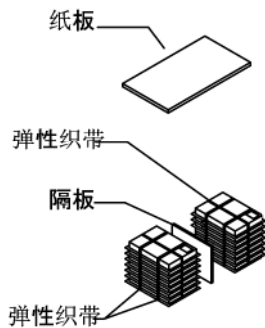

圖三

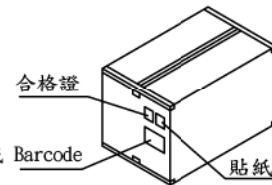
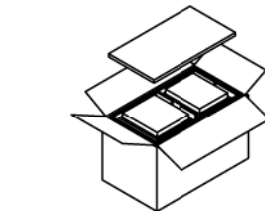

圖四

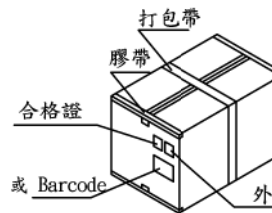

圖四

一. 成品包裝方式:

1. 成品如圖示放入盤內, 裝滿后蓋上上蓋, 上蓋之右上角貼標籤或BAR CODE(如圖示), 內容以蓋章或電腦方式填入。
2. 裝滿后将包裝盤方向一致地層層疊放, 10盤一組, 每層放1PCS cover, 用3PCS彈性繃帶捆著一組產品, (如圖) 一共二組。

二. 紙箱包裝方式:

1. 外箱紙箱1pc.
2. 紙箱兩邊放入围板各1pc.
3. 底層放入紙板1pc.
4. 放入防水袋1pc, 然后放入二疊產品, 在每二疊產品間放入隔板各1pc.
5. 封箱前于防水袋外, 再放入紙板1pc.
6. 蓋上箱子, 用TAPE封合后, 在外箱標志內, 貼貼紙一張。

- * 若出貨為成品時, 每箱實重應以實測重量為準。
- * 出貨時, 零箱部分需以空盤或泡棉確實填滿。
- * 成品若需空運出貨, 則如圖四打包。

1. 紙箱 長X寬X高=385X355X200 mm
2. 包裝重量以實際測量為準。
3. 包材和產品中包含之有害物質 (環境管理物質) 符合ROHS規定。

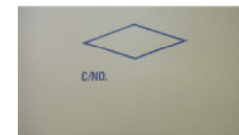

正參



側參

包裝容量 PACKING CAPACITY			重量 WEIGHT(kg)		
PCS/INNER PACKAGING	INNER PACKAGING / BOX	PCS / BOX	N.W. / PC	N.W. / BOX	G.W. / BOX
24	20	480	0.0159	7.632	10.15

UNLESS OTHERWISE SPECIFIED TOLERANCE		 CHANT SINCERE CO.,LTD TEL:086-02-86471251 FAX:086-02-86472962
ANG.	± 3*	
.0	± 0.35	
.00	± 0.25	
.000	± 0.15	
SCALE:	AS SHOWN	UNIT: mm
DRAWN:	PEARL	05/04/2016
CHECKED:		
APPROVED:		
DRAWN NAME:		DRAWN NAME:
QUADRUPLE STACKED		QUADRUPLE STACKED
USB 3.0 A TYPE CONNECTOR		USB 3.0 A TYPE CONNECTOR 3/3
PRODUCT NO.		PRODUCT NO.
377AX36FXTSFNXAX		377AX36FXTSFNXAX
FILE NAME:		FILE NAME:
377AX36FXTSFNXAB(A07)		377AX36FXTSFNXAB(A07)

REV.	DESCRIPTION	DATE	SIZE	REV.
1			A4	X3