

**RoHS**  
compliant

**PRELIMINARY**

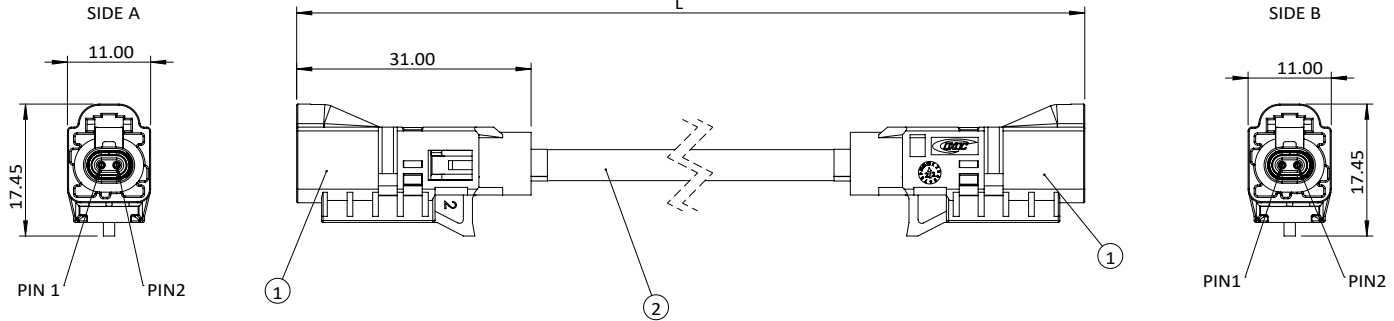

**SPECIFICATION**

**ELECTRICAL:**

1. FINISHED CABLE 100% CONDUCTIVITY TEST
2. FREQUENCY: 1 GHz
3. CHARACTERISTIC IMPEDANCE: 100 Ω
4. INSULATION RESISTANCE: ≥ 100 MΩ

**ENVIRONMENTAL:**

1. OPERATING TEMPERATURE: -40°C TO +105°C

**MECHANICAL:**

1. CONNECTOR INSERTION FORCE: ≤ 45N
2. CONNECTOR WITHDRAWAL FORCE: ≥ 5N
3. MATING CYCLES: ≥ 25 CYCLES
4. RETENTION FORCE LATCH: ≥ 110N

**PACKAGING:**

1. QUANTITY: SINGLE PACK

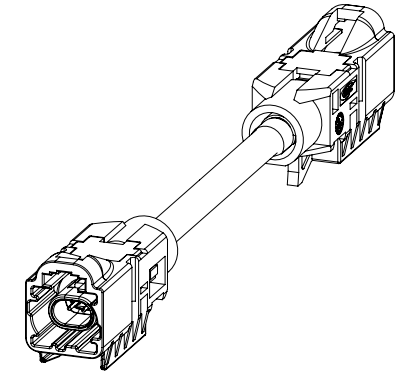
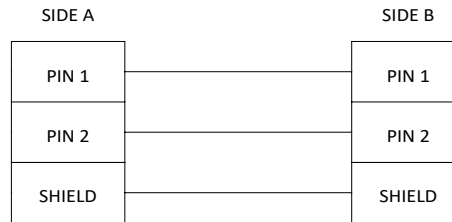

**LENGTH TOTAL TOLERANCE:**

- 1M > L ±15mm
- 2M > L ≥ 1M ±30mm
- 5M > L ≥ 2M ±50mm
- 10M > L ≥ 5M ±100mm
- ≥ 10M ±150mm







2	CABLE	DIFFIERENTIAL CABLE, 26AWGx2C, OD: 3.8mm, BLACK	A/R
1	HCMTD 1x1 plug	THERMOPLASTIC UL94V-0, 6μ" GOLD	2
ITEM	PART NAME	DESCRIPTION	QTY







1442601002Z	Z CODE/Z CODE	1000 ±30mm COXOC LOGO
1442601001Z	Z CODE/Z CODE	1000 ±30mm NONE LOGO
PART NUMBER	CODING	LENGTH
UNLESS OTHERWISE SPECIFIED TOLERANCE ANG. ±5° 0. ±0.50 .0 ±0.30 .00 ±0.20	SIP	 <b>CHANT SINCERE CO.,LTD</b> TEL:+886-2-8647-1251 WWW.COXOC.COM.TW
	CrmK Cpk	
SCALE: 1:1	UNIT: mm	TITLE: HMTD-N 1X1 PLUG CABLE
DRAWN: KEVIN_CHUEH	05 Feb 2024	
CHECKED: WEIWEI_CHANG	05 Feb 2024	PART NO. 1442601
APPROVED: JASON_HUANG	05 Feb 2024	
SIZE A4	SHEET 1/2	REV. X1
CODE:		CUSTOMER:



ZONE		REVISION	DESCRIPTION	DATE	SIZE A4 SHEET 1/2		REV. X1	CODE:	CUSTOMER:
1	2	3	4	5	6	7	8	9	10

**RoHS**  
compliant

**PRELIMINARY**

CODING	CODING A	CODING B	CODING C	CODING D	CODING E	CODING F	CODING G
COLOR	JET BLACK	PURE WHITE	LIGHT BLUE	CLARET VIOLET	MAY GREEN	NUT BROWN	PLATINUM GREY
RAL	SIM.9005	SIM.9010	SIM.5012	SIM.4004	SIM.6017	SIM.8011	SIM.7036
1X1							

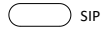
CODING	CODING H	CODING J	CODING K	CODING L	CODING M	CODING O	CODING Z
COLOR	LIGHT PINK	BEIGE	CURRY	YELLOW GREEN	PASTEL ORANGE	LIGHT GREEN	WATER BLUE
RAL	SIM.3015	SIM.1001	SIM.1027	SIM.6018	SIM.2003	SIM. 6027	SIM.5021
1X1							

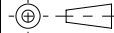
UNLESS OTHERWISE SPECIFIED TOLERANCE		 SIP
ANG.	±5°	 CrmK Cpk
0.	±0.50	
.0	±0.30	
.00	±0.20	
SCALE:	1 : 1	UNIT: mm
DRAWN:	KEVIN_CHUEH	05 Feb 2024
CHECKED:	WEIWEI_CHANG	05 Feb 2024
APPROVED:	JASON_HUANG	05 Feb 2024
	SIZE A4	SHEET 2/2
	REV.	X1



**CHANT SINCERE CO.,LTD**  
TEL:+886-2-8647-1251 WWW.COXOC.COM.TW

TITLE: HMTD-N 1X1 PLUG CABLE		
PART NO.	1442601	C
CODE:		CUSTOMER:

ZONE	REVISION	DESCRIPTION	DATE
1	X1		09DEC22