

RoHS
compliant

PRELIMINARY

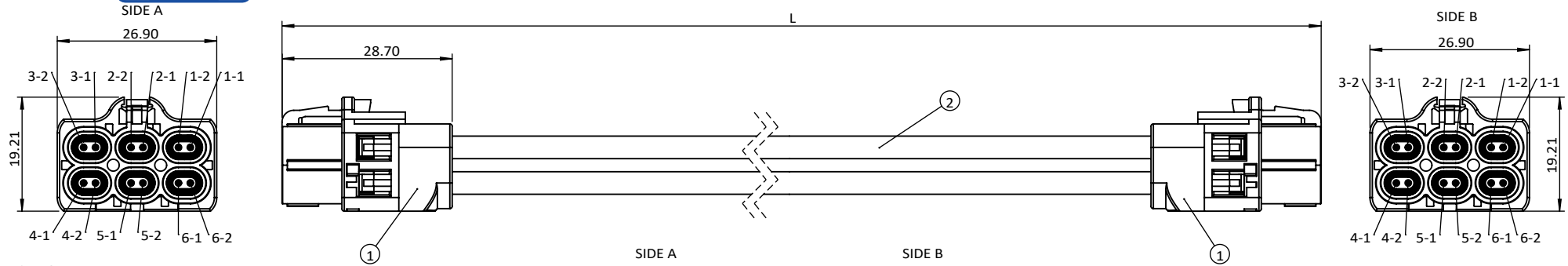

SPECIFICATION

ELECTRICAL:

1. FINISHED CABLE 100% CONDUCTIVITY TEST
2. FREQUENCY: 1 GHz
3. CHARACTERISTIC IMPEDANCE: 100 Ω
4. INSULATION RESISTANCE: ≥ 100 MΩ

ENVIRONMENTAL:

1. OPERATING TEMPERATURE: -40°C TO +105°C

MECHANICAL:

1. INSERTION FORCE: ≤ 75N
2. WITHDRAWAL FORCE: ≥ 5N
3. MATING CYCLES: ≥ 25 CYCLES
4. RETENTION FORCE LATCH: ≥ 110N

PACKAGING:

1. QUANTITY: SINGLE PACK
- PART NO.

SIDE A		SIDE B	
1-1		1-1	
1-2		1-2	
2-1		2-1	
2-2		2-2	
3-1		3-1	
3-2		3-2	
4-1		4-1	
4-2		4-2	
5-1		5-1	
5-2		5-2	
6-1		6-1	
6-2		6-2	
SHIELD		SHIELD	

LENGTH TOTAL TOLERANCE:

- 1M > L ±15mm
- 2M > L ≥ 1M ±30mm
- 5M > L ≥ 2M ±50mm
- 10M > L ≥ 5M ±100mm
- ≥ 10M ±150mm

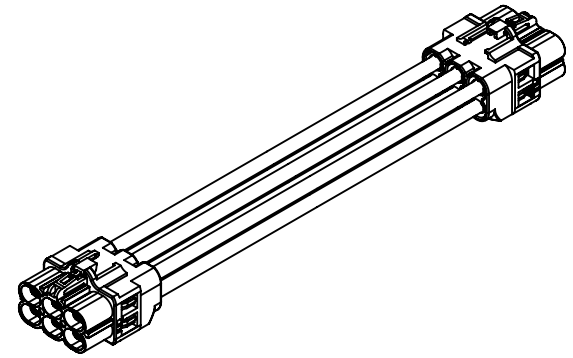

UNLESS OTHERWISE SPECIFIED TOLERANCE		SIP CrK Cpk		 CHANT SINCERE CO.,LTD TEL:+886-2-8647-1251 WWW.COXOC.COM.TW	
ANG.	±2°	0.	±0.30		
.0	±0.20	.00	±0.10	SCALE: AS SHOWN	UNIT: mm
DRAWN: KEVIN_CHUEH		05 Feb 2024		TITLE: HMTD-N 2X3 JACK CABLE	
CHECKED: WEIWEI_CHANG		05 Feb 2024		PART NO. 1440401001X	
APPROVED: JASON_HUANG		05 Feb 2024		REV. X1	
SIZE A4 SHEET 1/2		CODE:		CUSTOMER:	

ITEM	PART NAME	DESCRIPTION	QTY
2	CABLE	DIFFIERENTIAL CABLE, 26AWGx2C, OD: 3.8mm, BLACK	A/R
1	HCMTD 2x3 JCK	THERMOPLASTIC UL94V-0, 30μ" GOLD	2

ZONE	REVISION	DESCRIPTION	DATE
1	X1		29MAR2023

G
F
E
D
C
B
A

G
F
E
D
C
B
A

1 2 3 4 5 6 7 8 9 10



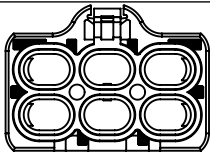
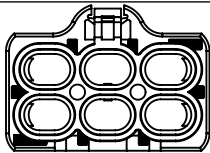
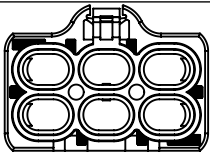
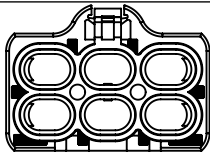
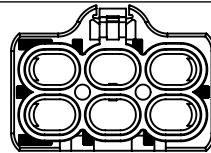
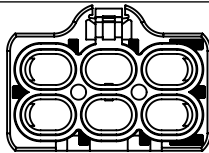
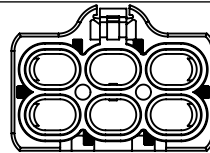

1 2 3 4 5 6 7 8 9 10

RoHS
compliant

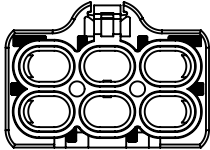
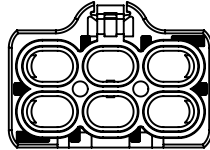
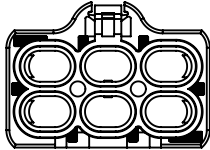
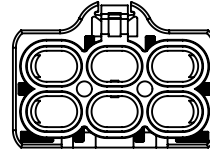
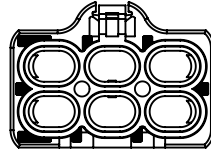
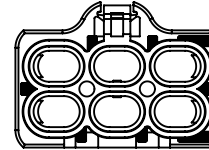
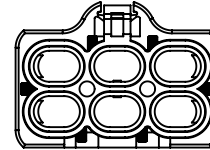
PRELIMINARY

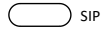
CODING	CODING A	CODING B	CODING C	CODING D	CODING E	CODING F	CODING Z
COLOR	JET BLACK	PURE WHITE	LIGHT BLUE	CLARET VIOLET	MAY GREEN	NUT BROWN	WATER BLUE
RAL	SIM.9005	SIM.9010	SIM.5012	SIM.4004	SIM.6017	SIM.8011	SIM.5021
2X3							

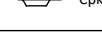
CODING	CODING G	CODING H	CODING J	CODING K	CODING L	CODING M	CODING O
COLOR	PLATINUM GREY	LIGHT PINK	BEIGE	CURRY	YELLOW GREEN	PASTEL ORANGE	LIGHT GREEN
RAL	SIM. 7036	SIM. 3015	SIM. 1001	SIM. 1027	SIM. 6018	SIM. 2003	SIM. 6027
2X3							

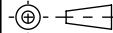
UNLESS OTHERWISE SPECIFIED TOLERANCE		 SIP  Crk  Cpk		 CHANT SINCERE CO.,LTD TEL:+886-2-8647-1251 WWW.COXOC.COM.TW	
SCALE:	AS SHOWN	UNIT:	mm		
DRAWN:	KEVIN_CHUEH	05 Feb 2024	TITLE: HMTD-N 2X3 JACK CABLE		
CHECKED:	WEIWEI_CHANG	05 Feb 2024			
APPROVED:	JASON_HUANG	05 Feb 2024	PART NO.	1440401001X	P
	SIZE A4	SHEET 2/2	REV.	X1	CODE: CUSTOMER:

ZONE	REVISION	DESCRIPTION	DATE
1	X1		29MAR2023