

RoHS compliant

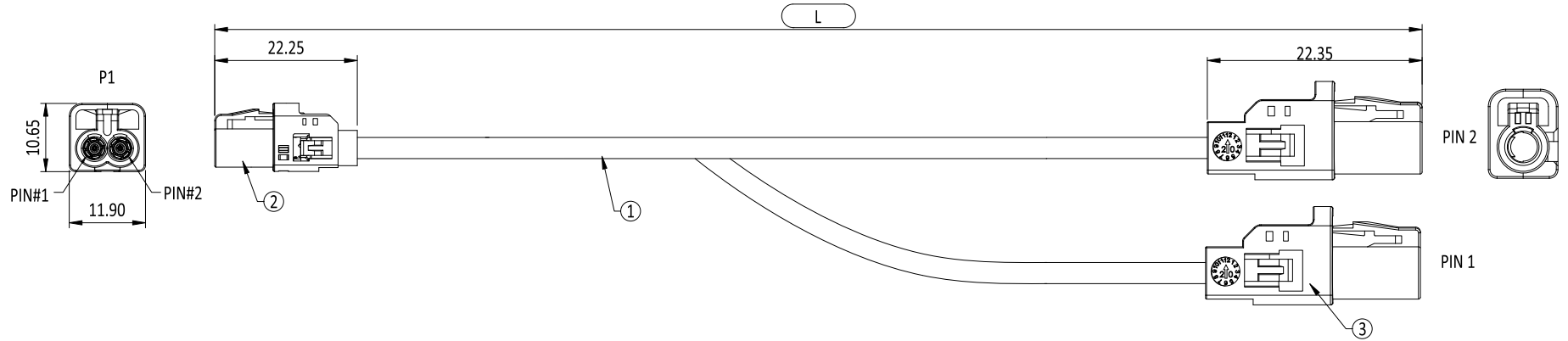

SPECIFICATION:
ELECTRICAL CHARACTERISTIC:
 1. FINISHED CABLE 100% CONDUCTIVITY TEST
 2. CHARACTERISTIC IMPEDANCE: 50 Ω
 3. TEST VOLTAGE: DC 500V
 4. OPERATE VOLTAGE: 12.6V±5%

ENVIRONMENTAL :
 1. OPERATING TEMPERATURE: -40°C TO +105°C

3	MINI FAKRA A 1x1 JACK	THERMOPLASTIC UL94V-0, 30u"AU	2
2	MINI FAKRA A 1x2 JACK	THERMOPLASTIC UL94V-0, 30u"AU	1
1	CABLE	031 CABLE : 22 AWG COAXLAL+AL+MYLAR+BRAID, OD: 3.2mm, JACKET: PVC BLACK	A/R
ITEM	PART	DESCRIPTION	QTY

2	1420105002Z	3000±50mm	Z/Z	
1	1420105001Z	2000±50mm	Z/Z	
ITEM	P/N	L (LENGTH)	CODE	NOTE

UNLESS OTHERWISE SPECIFIED TOLERANCE
 ANG. ±5°
 0. ±0.50
 .0 ±0.30
 .00 ±0.20

SIP
 Crk
 Cpk



SCALE: AS SHOWN UNIT: mm
 DRAWN: BENSON_ZHENG 07 Feb 2024
 CHECKED: PEARL_HUNG 07 Feb 2024
 APPROVED: PEARL_HUNG 07 Feb 2024

TITLE:
 MINI FAKRA A JACK 1x2/MINI FAKRA A JACKx2 CABLE
 PART NO. 1420105XXXX
 CODE: GC CUSTOMER:

SIZE A4 SHEET 1/4 REV. B

	B	ECN-2401122(VIVI)ADD P/N	01FEB2024
	A	ECN-2312052(ADA)ADD NEW	14DEC2023
ZONE	REVISION	DESCRIPTION	DATE

RoHS
compliant



A	B	C	D	E	F
JET BLACK SIMILAR RAL 9005	PURE WHITE SIMILAR RAL 9010	LIGHT BLUE SIMILAR RAL 5012	CLARET VIOLET SIMILAR RAL 4004	MAY GREEN SIMILAR RAL 6017	NUT BROWN SIMILAR RAL 8011
G	H	J	K	N	Z
PLATINUM GREY SIMILAR RAL 7036	LIGHT PINK SIMILAR RAL 3015	BEIGE SIMILAR RAL 1001	CURRY SIMILAR RAL 1027	PASTEL GREEN SIMILAR RAL 6019	WATER BLUE SIMILAR RAL 5021

UNLESS OTHERWISE SPECIFIED TOLERANCE	
ANG.	±5°
0.	±0.50
.0	±0.30
.00	±0.20

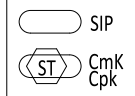

SCALE:	2:1	UNIT:	mm
DRAWN:	BENSON_ZHENG	07 Feb 2024	
CHECKED:	PEARL_HUNG	07 Feb 2024	
APPROVED:	PEARL_HUNG	07 Feb 2024	

TITLE:	MINI FAKRA A JACK 1x2/MINI FAKRA A JACKx2 CABLE	
PART NO.	1420105XXXX	
CODE:	GC	CUSTOMER:

	B	ECN-2401122(VIVI)SEE PAGE 1/4	01FEB2024
	A	ECN-2312052(ADA)ADD NEW	14DEC2023
ZONE	REVISION	DESCRIPTION	DATE

RoHS
compliant



A	B	C	D	E	F
JET BLACK SIMILAR RAL 9005	PURE WHITE SIMILAR RAL 9010	LIGHT BLUE SIMILAR RAL 5012	BORDEAUX VIOLET SIMILAR RAL 4004	MAY GREEN SIMILAR RAL 6017	NUT BROWN SIMILAR RAL 8011
G	H	J	K	Z	
PLATINUM GREY SIMILAR RAL 7036	LIGHT PINK SIMILAR RAL 3015	BEIGE SIMILAR RAL 1001	CURRY SIMILAR RAL 1027	WATER BLUE SIMILAR RAL 5021	

UNLESS OTHERWISE SPECIFIED TOLERANCE	
ANG.	±5°
0.	±0.50
.0	±0.30
.00	±0.20

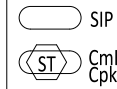

CHANT SINCERE CO.,LTD

SCALE:	2:1	UNIT:	mm
DRAWN:	BENSON_ZHENG		07 Feb 2024
CHECKED:	PEARL_HUNG		07 Feb 2024
APPROVED:	PEARL_HUNG		07 Feb 2024

TITLE:	MINI FAKRA A JACK 1x2/MINI FAKRA A JACKx2 CABLE
PART NO.	1420105XXXX
CODE:	GC
CUSTOMER:	

	B	ECN-2401122(VIVI)SEE PAGE 1/4		01FEB2024
	A	ECN-2312052(ADA)ADD NEW		14DEC2023
ZONE	REVISION	DESCRIPTION		DATE

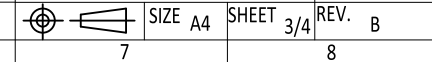

1	2	3	4	5	6	7	8	9	10
---	---	---	---	---	---	---	---	---	----

RoHS
compliant

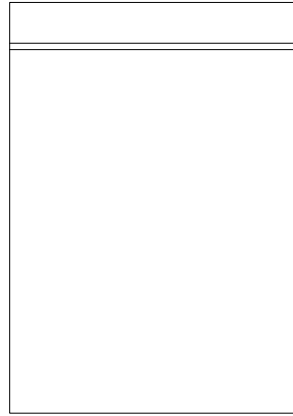
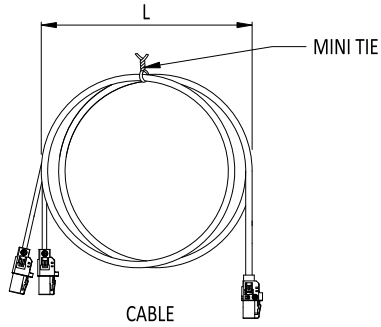

240(L)x170(W) ZIP BAG

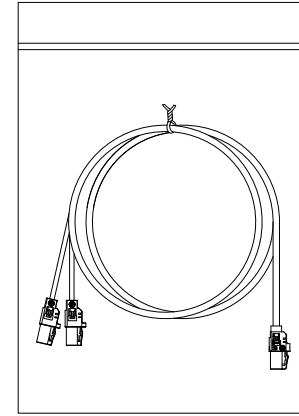

1PC/ZIP BAG

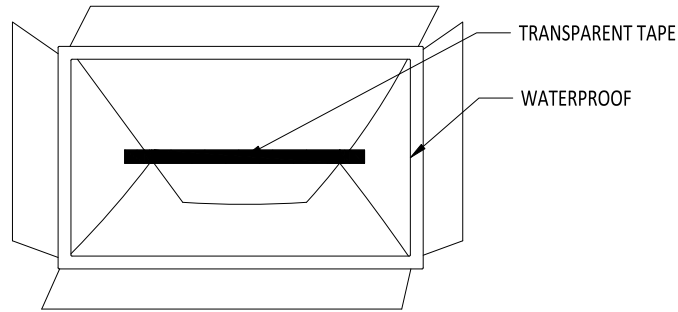
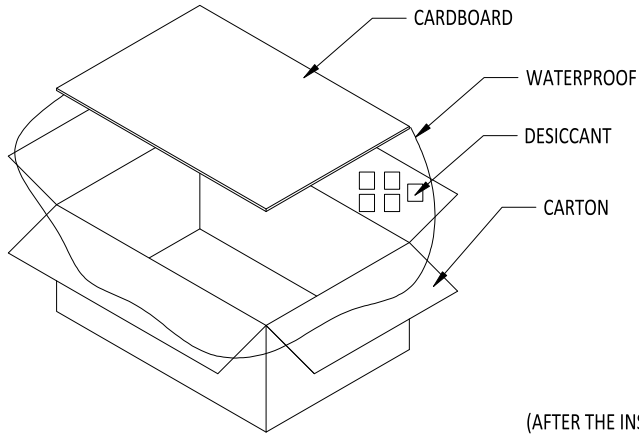

(AFTER THE INSTALLED PRODUCT, CARTON SEALING TAPE SHOULD BE TRANSPARENT)

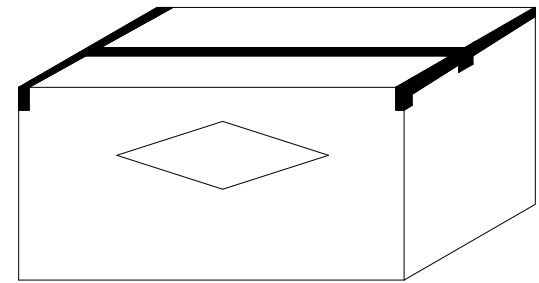

100PCS/CARTON
裝箱數量依首批訂單為主

5	M90000EZ0000029	DESICCANT	2g	5 PCS/CARTON
4	M9BE71163507009	WATERPROOF	28"x25"x0.07mm	1 PC/CARTON
3	M9EE330330000300	CARDBOARD(B3B)	330x330mm	2 PCS/CARTON
2	M9CE406330165500	CARTON	16"x13"x6.5"	100 PCS/CARTON
1	MQR1000NB10A0850	ZIP BAG FOR	240(L)x170(W)mm	1 PC/BAG

ITEM	PART NO.	DIMENSION	SPECIFICATION	AMOUNT
DETAILED ITEM				

100	--	--
BAG/CARTON	N.W(g)	G.W(g)
QUANTITY	WEIGHT	
NOTE		

UNLESS OTHERWISE SPECIFIED TOLERANCE	SIP	 CHANT SINCERE CO.,LTD
ANG. ±5°	ST Cmk Cpk	
0. ±0.50		
.0 ±0.30		
.00 ±0.20		
SCALE: AS SHOWN	UNIT: mm	

DRAWN: BENSON_ZHENG		07 Feb 2024		TITLE: MINI FAKRA A JACK 1x2/MINI FAKRA A JACKx2 CABLE	
CHECKED: PEARL_HUNG		07 Feb 2024		PART NO. 1420105XXXX	
APPROVED: PEARL_HUNG		07 Feb 2024		CODE: GC CUSTOMER:	
①	SIZE A4	SHEET 4/4	REV. B		

ZONE	REVISION	DESCRIPTION	DATE
1	2	3	4
	B	ECN-2401122(VIVI)SEE PAGE 1/4	01FEB2024
	A	ECN-2312052(ADA)ADD NEW	14DEC2023