

RoHS
compliant

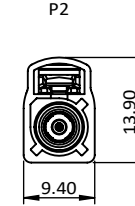
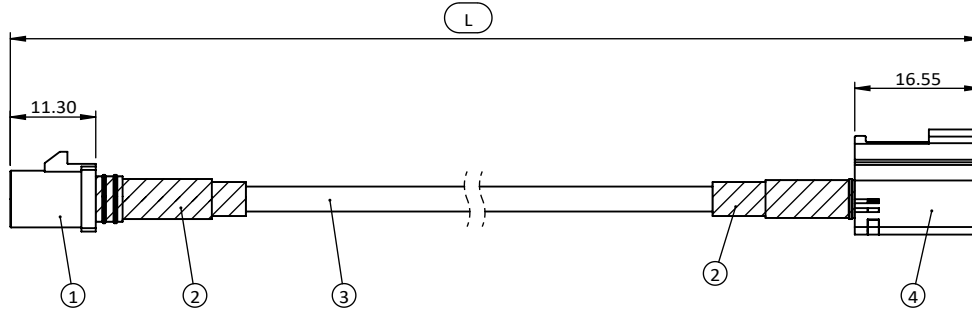
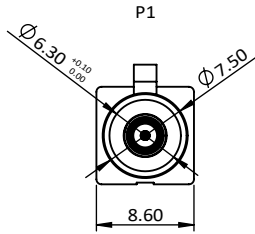

SPECIFICATION

- ELECTRICAL:**
- 1.FINISHED CABLE 100% CONDUCTIVITY TEST
 - 2.CHARACTERISTIC IMPEDANCE: 50 Ω
 - 3.FREQUENCY: DC TO 4 GHz
 - 4.VSWR: 1.50MAX.@0~3GHz; 1.80MAX.@3~4GHz
 - 5.INSULATION RESISTANCE: ≥100 MΩ

ENVIRONMENTAL:

- 1.OPERATING TEMPERATURE: -40 °C TO +150 °C
- 2.WATER TIGHTNESS IP69K

MECHANICAL: GAGEMENT FORCE:

- 1.CONNECTOR INSERTION FORCE: ≤25N
- 2.DISENGAGEMENT FORCE: ≥2N
- 3.MATING CYCLE: ≥25 CYCLES
- 4.RETENTION FORCE LATCH: ≥110 DINGN
- 5.CODING EFFICIENCY: ≥40N
- 6.USCAR-17 COMPLIANT

PACKAGING:

- 1.QUANTITY: SINGLE PACK

FAKRA LOGO OPTIONS

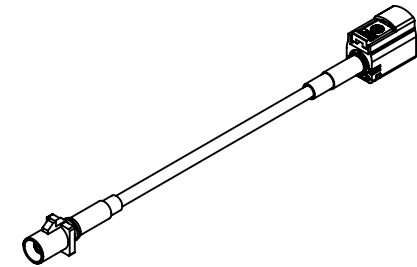
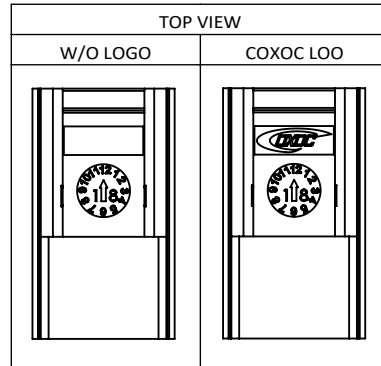

SCALE1:2

4	FAKRA STR. JACK	THERMOPLASTIC UL94-V0, 30u" AU	1
3	CABLE	O31 CABLE: 22AWG COAXLAL+AL+MYLAR+BRAID, OD: 3.2mm, JACKET: PVC BLACK	A/R
2	HST	HEAT SHRINK TUBE WITH GLUE,BLACK	2
1	FAKRA STR. PLUG	THERMOPLASTIC UL94-V0, 30u" AU	1
ITEM	PART	DESCRIPTION	QTY

△C	4	1413201004Z	CWS22ZZ3A01E10M	10000±150mm	Z/Z CODE	W/O LOGO
△C	3	1413201003Z	CWS22ZZ3A01E5M0	5000±100mm	Z/Z CODE	W/O LOGO
△C	2	1413201002Z	CWS22ZZ3A01E2M0	2000±50mm	Z/Z CODE	W/O LOGO
△B	1	1413201001Z	CWS22ZZ3A01E3M0	3000±50mm	Z/Z CODE	W/O LOGO
ITEM	NEW P/N	OLD P/N	LENGTH	CODING	LOGO	

UNLESS OTHERWISE SPECIFIED TOLERANCE		SIP
ANG. ±5°	0. ±0.50	ST Crk Cpk
.0 ±0.30	.00 ±0.20	
SCALE: 1.5:1	UNIT: mm	



A5, B6, C6	C	ECN-2312062(TINA)ADDED LENGTH SPECIFICATIONS △C	19DEC2023
B6	B	ECN-2307006(JENNY)ADD NEW P/N&MODIFY HST TITLE	04JUL2023
	A	ECN-2302053(OLIVER)NEW RELEASE	23FEB2023
ZONE	REVISION	DESCRIPTION	DATE

DRAWN: KEVIN_ZHENG	16 Feb 2024	TITLE: FAKRA PLUG TO FAKRA JACK_031 CABLE FOR IP69K
CHECKED: PEARL_HUNG	16 Feb 2024	
APPROVED: PEARL_HUNG	16 Feb 2024	
REV. C	PART NO. 1413201XXXX	C
SIZE A4	SHEET 1/4	CODE: GC
		CUSTOMER:

RoHS
compliant



A	B	C	D	E	F	G
JET BLACK SIM. 9005	CREAM WHITE SIM. 9001	SIGNAL BLUE SIM. 5005	CLARET VIOLET SIM. 4004	LEAF GREEN SIM. 6002	NUT BROWN SIM. 8011	BLUE GRAY SIM. 7031
H	I	K	L	M	N	Z
HEATHER VIOLET SIM. 4003	BEIGE SIM. 1001	CURRY SIM. 1027	CARMINE RED SIM. 3002	PASTEL ORANGE SIM. 2003	PASTEL GREEN SIM. 6019	WATER BLUE SIM. 5021

UNLESS OTHERWISE SPECIFIED TOLERANCE	
ANG.	±5°
0.	±0.50
.0	±0.30
.00	±0.20

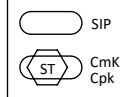

SCALE: 2:1	UNIT: mm
DRAWN: KEVIN_ZHENG	16 Feb 2024
CHECKED: PEARL_HUNG	16 Feb 2024
APPROVED: PEARL_HUNG	16 Feb 2024

TITLE: FAKRA PLUG TO FAKRA JACK_031 CABLE FOR IP69K

PART NO. 1413201XXXX

C	ECN-2312062(TINA)SEE PAGE 1/4	19DEC2023	
B	ECN-2307006(JENNY)SEE PAGE 1/4	04JUL2023	
A	ECN-2302053(OLIVER)NEW RELEASE	23FEB2023	
ZONE	REVISION	DESCRIPTION	DATE

	SIZE A4	SHEET 2/4	REV. C	CODE: GC	CUSTOMER:
--	---------	-----------	--------	----------	-----------

RoHS
compliant

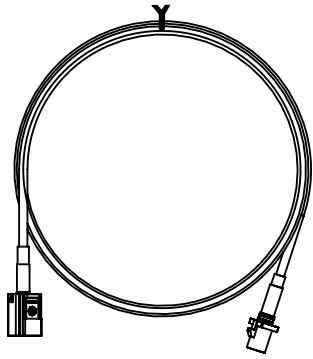

FAKRA PLUG TO JACK CABLE

+

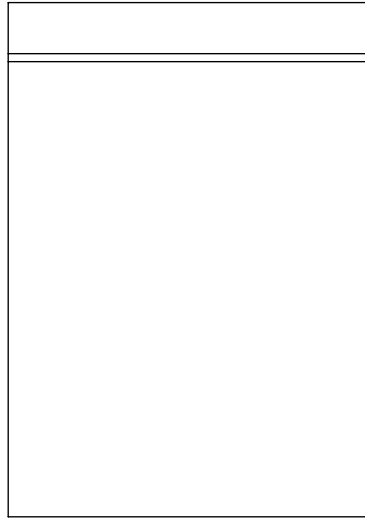

ZIP BAG: 203(L)X165(W)XT0.05mm

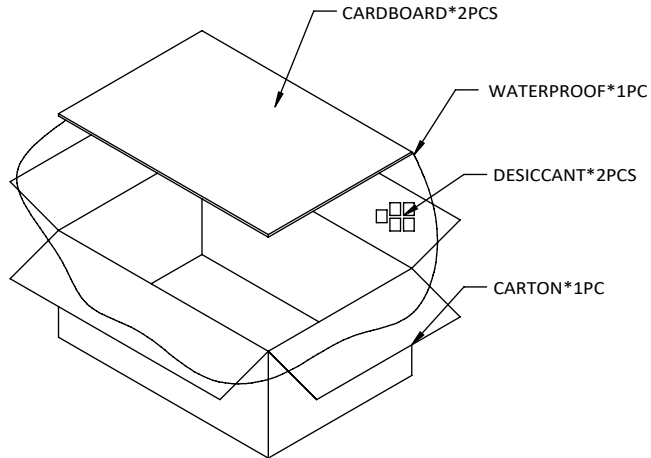
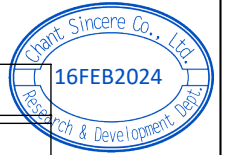
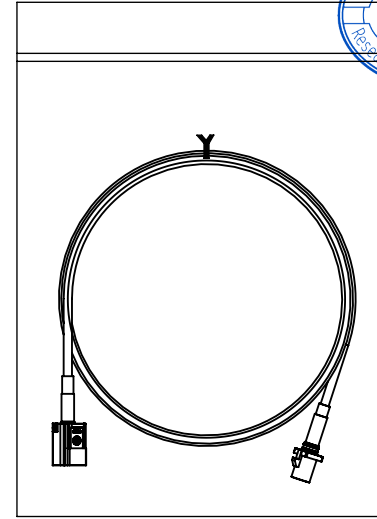

CARTON: 420(L)X350(W)X310(H)

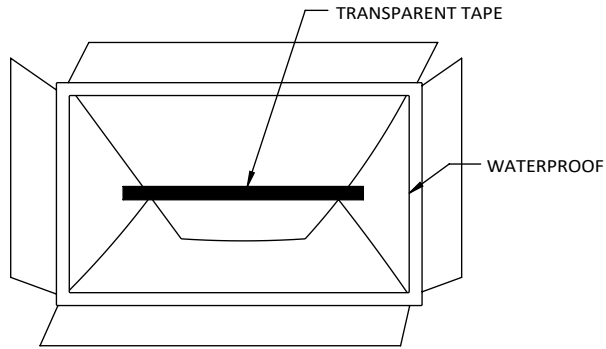

(AFTER THE INSTALLED PRODUCT,
CARTON SEALING TAPE SHOULD BE TRANSPARENT)

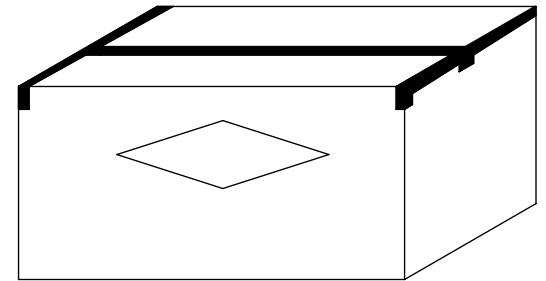

裝箱數量依首批訂單為主

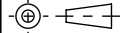
UNLESS OTHERWISE SPECIFIED TOLERANCE		SIP		 CHANT SINCERE CO.,LTD		
ANG.	±5°	CmK Cpk				
0.	±0.50	UNIT: mm		TITLE: FAKRA PLUG TO FAKRA JACK_031 CABLE FOR IP69K		
.0	±0.30	DRAWN: KEVIN_ZHENG				16 Feb 2024
.00	±0.20	CHECKED: PEARL_HUNG				16 Feb 2024
SCALE: 1:3		APPROVED: PEARL_HUNG		16 Feb 2024	PART NO. 1413201XXXX	
 SIZE A4		SHEET 4/4		REV. C	CODE: GC CUSTOMER:	

ZONE	REVISION	DESCRIPTION	DATE
1	2	3	4
	C	ECN-2312062(TINA)SEE PAGE 1/4	19DEC2023
	B	ECN-2307006(JENNY)SEE PAGE 1/4	04JUL2023
	A	ECN-2302053(OLIVER)NEW RELEASE	23FEB2023