

RoHS compliant

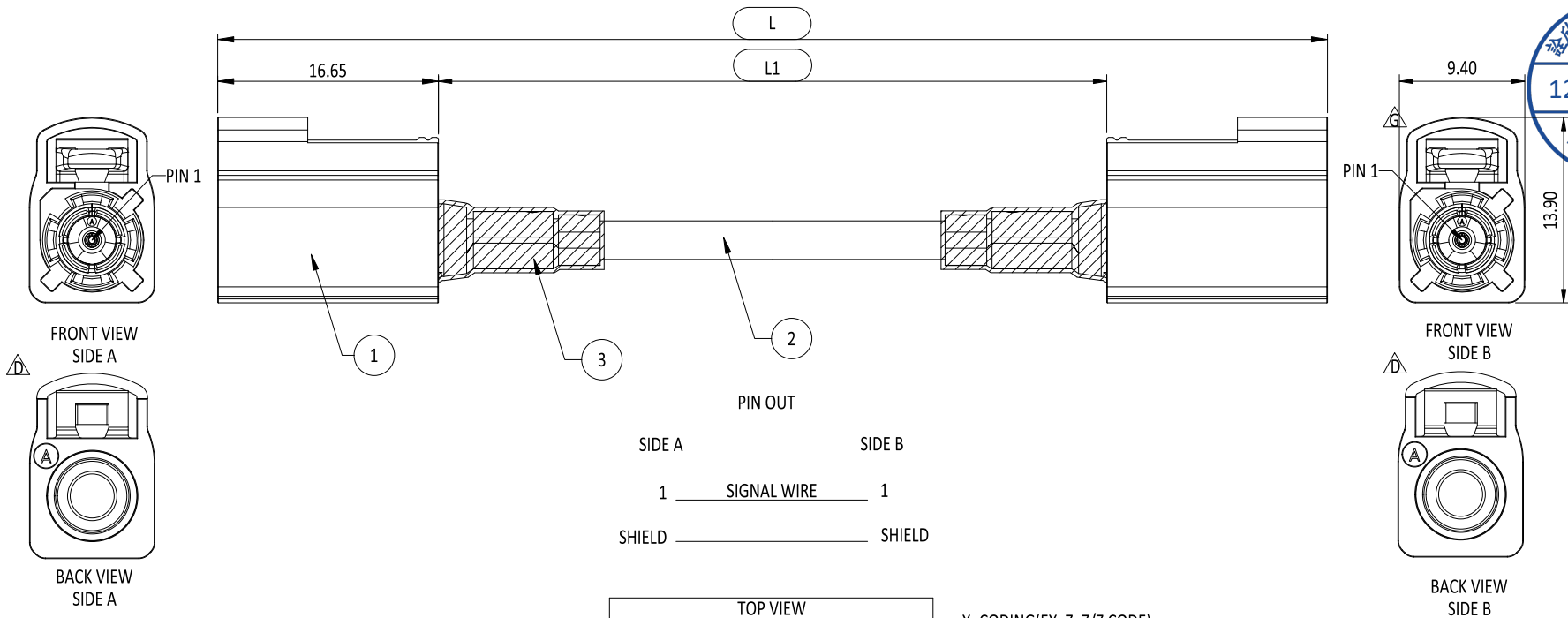

- SPECIFICATION**
- ELECTRICAL CHARACTERISTIC:**
1. CHARACTERISTIC IMPEDANCE: 50 Ω
  2. FINISHED CABLE 100% CONDUCTIVITY TEST
  3. FREQUENCY: DC TO 4.0 GHz
  4. VSWR: 1.50 MAX.@0~4.0 GHz
  5. INSULATION RESISTANCE: ≥100MΩ
- MECHANICAL CHARACTERISTIC:**
1. CONNECTOR INSERTION FORCE: ≤ 25 N
  2. DISENGAGEMENT FORCE: ≥ 2 N
  3. MATING CYCLE: ≥ 25 CYCLES
  4. RETENTION FORCE LATCH: ≥110 N
  5. MISMATING ORIENTATION EFFECTIVENESS: ≥40N
  6. USCAR-17 COMPLIANT
- ENVIRONMENT:**
1. OPERATING TEMPERATURE RANGE: -40°C TO +105°C

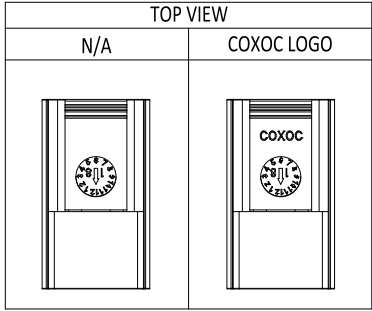

X=CODING(EX. Z=Z/Z CODE)

P/N	CODE	LENGTH	LOGO	
1410301015X	N/A	L1=2000±50mm	COXOC LOGO	
1410301014X	N/A	L=15000±150mm	COXOC LOGO	
1410301013X	N/A	L=10000±150mm	COXOC LOGO	
1410301012X	N/A	L=3000±50mm	N/A	
1410301011X	N/A	L=5000±100mm	COXOC LOGO	
1410301010X	N/A	L=17000±150mm	COXOC LOGO	
1410301009X	N/A	L=9000±100mm	COXOC LOGO	
1410301008X	N/A	L=600±15mm	N/A	
1410301007X	C7S24XX3A02SE6M0	L=6000±100mm	COXOC LOGO	
1410301006X	C7S24XX3A02SE2M0	L=2000±50mm	COXOC LOGO	
1410301005X	C7S24XX3A02SE1M7	L=1700±30mm	COXOC LOGO	
1410301004X	C7S24XX3A02SE1M0	L=1000±30mm	COXOC LOGO	
1410301003X	C7S24XX3A02SE50C	L=500±15mm	COXOC LOGO	
1410301002X	C7S24XX3A02SE3M5	L=3500±50mm	COXOC LOGO	
1410301001X	C7S24XX3A02E1M0	L=1000±30mm	N/A	
NEW P/N	OLD P/N	LENGTH	LOGO	NOTE

ITEM	PART	DESCRIPTION	Q'TY
3	HST	HEAT SHRINK TUBE, BLACK	2
2	RTK031 CABLE	22AWG COAXIAL+AL-MYLAR+BRAID, OD: 3.3±0.2mm, JACKET: PVC, BLACK	A/R
1	FAKRA JACK	THERMOPLASTIC UL94V-0, 30u" AU	2

UNLESS OTHERWISE SPECIFIED TOLERANCE

ANG.	±2°
0.	±0.50
.0	±0.30
.00	±0.20

SCALE: 2:1 UNIT: mm

SIP  
Cmk  
Cpk

**CHANT SINCERE CO.,LTD**

ZONE	REVISION	DESCRIPTION	DATE	DRAWN:	DATE	TITLE:
L		ECN-2601078(HOLLY)ADD P/N 1410301015X	23JAN2026	HOLLY_TU	23 Jan 2026	PDR-19063
K		ECN-2601032(JOAN)ADD P/N 1410301013X-014X	12JAN2026	PEARL_HUNG	23 Jan 2026	FAKRA JACK CABLE
A1, A10, B3, D6	J	ECN-2508125(JOAN)ADD P/N & UPDATE PART DESCRIPTION	29AUG2025	PEARL_HUNG	23 Jan 2026	PART NO. 1410301XXXX
1	2	3	4	5	6	7
SIZE A4	SHEET 1/3	REV. L	CODE: GC	CUSTOMER:		

RoHS  
compliant



\*=DEVELOPING

A	B	C	D	*E	*F	G
JET BLACK SIMILAR RAL 9005	CREAM WHITE SIMILAR RAL 9001	SIGNAL BLUE SIMILAR RAL 5005	CLARET VIOLET SIMILAR RAL 4004	LEAF GREEN SIMILAR RAL 6002	NUT BROWN SIMILAR RAL 8011	BLUE GRAY SIMILAR RAL 7031
H	I	*K	L	*M	*N	Z
HEATHER VIOLET SIMILAR RAL 4003	BEIGE SIMILAR RAL 1001	CURRY SIMILAR RAL 1027	CARMINE RED SIMILAR RAL 3002	PASTEL ORANGE SIMILAR RAL 2003	PASTEL GREEN SIMILAR RAL 6019	WATER BLUE SIMILAR RAL 5021

UNLESS OTHERWISE SPECIFIED TOLERANCE		SIP	 <b>CHANT SINCERE CO.,LTD</b>
ANG.	±2°	Cmk Cpk	
0.	±0.50	SCALE: 2:1	
.0	±0.30	UNIT: mm	
.00	±0.20	DRAWN: HOLLY_TU 23 Jan 2026	
TITLE: PDR-19063		CHECKED: PEARL_HUNG 23 Jan 2026	
FAKRA JACK CABLE		APPROVED: PEARL_HUNG 23 Jan 2026	
PART NO. 1410301XXXX		REV. L	
CODE: GC		CUSTOMER:	

L	ECN-2601078(HOLLY)SEE PAGE 1/3	23JAN2026	
K	ECN-2601032(JOAN)SEE PAGE 1/3	12JAN2026	
J	ECN-2508125(JOAN)SEE PAGE 1/3	29AUG2025	
ZONE	REVISION	DESCRIPTION	DATE

RoHS  
compliant

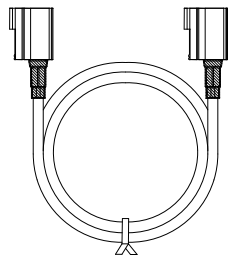

FAKRA STRAIGHT JACK CABLE

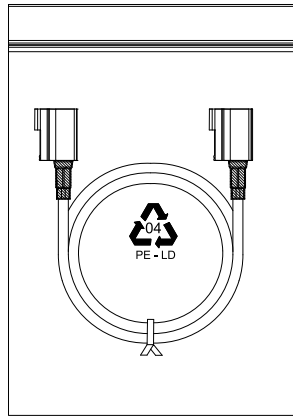

1PC CABLE/ZIP BAG

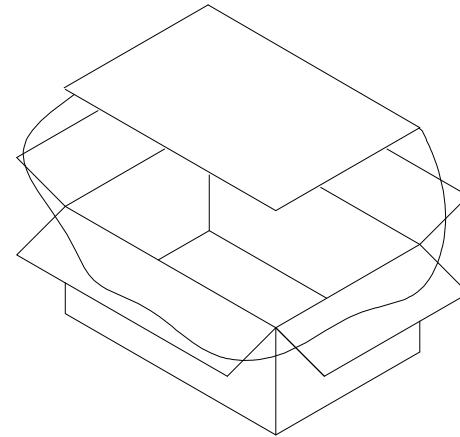

CARTON

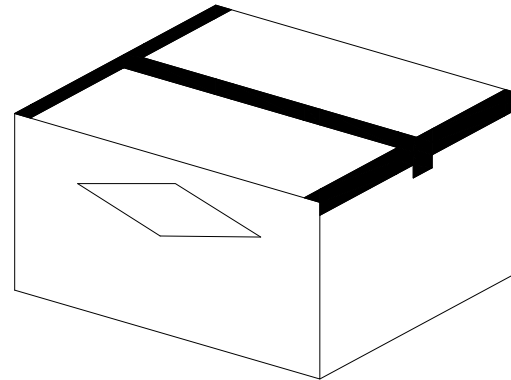
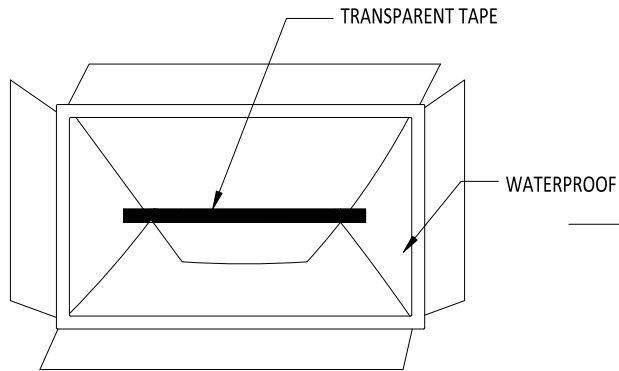

(裝箱數量依首批實際訂單為主)

包裝說明:

1. 單PCS成品繞線後放入夾鍊袋
2. 先在紙箱底部放一層隔板，再套一個防水袋，將產品整齊擺放至紙箱中，上面放入乾燥劑，收攏袋口，最後上層放一層隔板，裝好產品後，防水袋需用透明膠紙封口

5	DESICCANT	M90000EZ0000029	2g	1 PC/CARTON	
4	WATERPROOF	M9BE91461007009	914x610x0.07mm	1 PC/CARTON	
3	CARDBOARD(B3B)	M9EE430310000300	430x310mm	1 PC/CARTON	
2	CARTON	M9CE451330254500	17.75"x13"x10"	1 PC/CARTON	
1	ZIP BAG			1PC ZIP BAG	

UNLESS OTHERWISE SPECIFIED TOLERANCE		SIP
ANG.	±2°	ST
0.	±0.50	Cmk
.0	±0.30	Cpk
.00	±0.20	

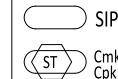

SCALE: AS SHOWN	UNIT: mm
DRAWN: HOLLY_TU	23 Jan 2026
CHECKED: PEARL_HUNG	23 Jan 2026
APPROVED: PEARL_HUNG	23 Jan 2026

TITLE: PDR-19063	
FAKRA JACK CABLE	
PART NO.	1410301XXXX
CODE: GC	CUSTOMER:

ITEM	DESCRIPTION	PART NUMBER	SPECIFICATION	Q'TY	NOTE
	L	ECN-2601078(HOLLY)SEE PAGE 1/3			23JAN2026
	K	ECN-2601032(JOAN)SEE PAGE 1/3			12JAN2026
	J	ECN-2508125(JOAN)SEE PAGE 1/3			29AUG2025
ZONE	REVISION	DESCRIPTION		DATE	
1	2	3	4	5	6

SIZE A4	SHEET 3/3	REV. L
---------	-----------	--------

7	8	9	10
---	---	---	----