

RoHS
compliant

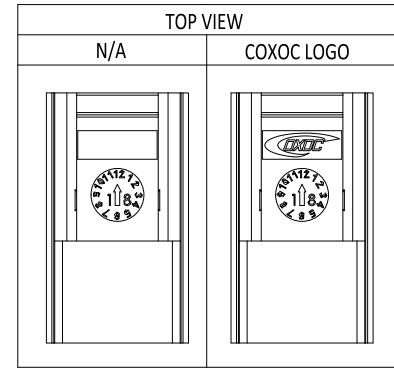
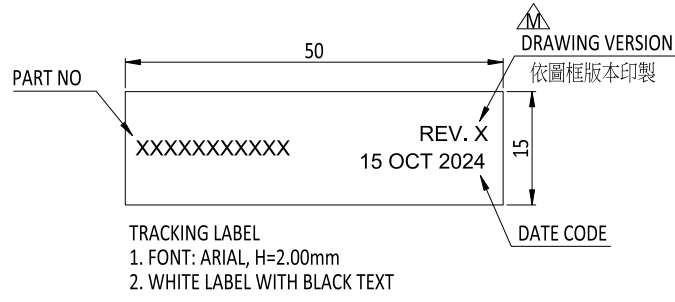
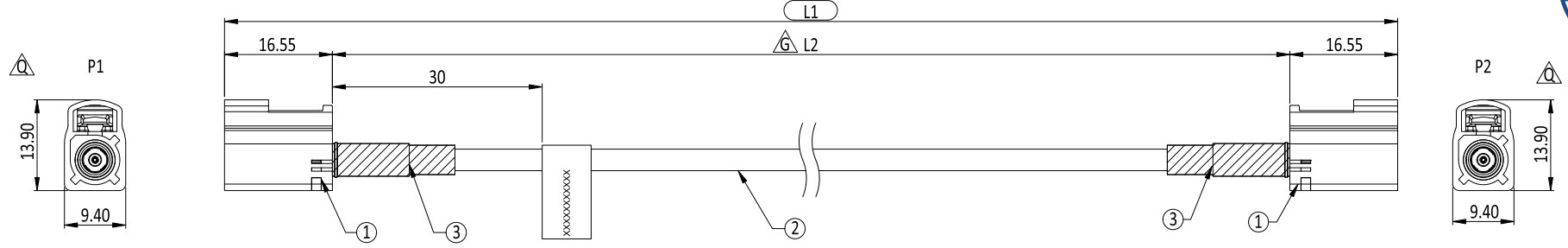

SPECIFICATION
ELECTRICAL CHARACTERISTIC:
 1. FINISHED CABLE 100% CONDUCTIVITY TEST
 2. CHARACTERISTIC IMPEDANCE: 50 Ω
 3. FREQUENCY RANGE: DC TO 6.0 GHz
 4. VSWR 1.5 MAX.@0~3.0GHz; 1.80MAX.@3.0~4.0GHz
 5. INSULATION RESISTANCE: ≥ 100 MΩ

MECHANICAL CHARACTERISTIC:
 1. CONNECTOR ENGAGEMENT FORCE: ≤ 25N
 2. DISENGAGEMENT FORCE: ≥ 2N
 3. DURABILITY: ≥ 25 CYCLES
 4. RETENTION FORCE LATCH: ≥ 110N
 5. MISMATING ORIENTATION EFFECTIVENESS: ≥ 40N
 6. ALL MATERIALS MUST BE USCAR-2, USCAR-17 COMPLIANT

ENVIRONMENTAL:
 1. OPERATING TEMPERATURE: -40°C TO +105°C
 2. WATER TIGHTNESS IP67

3	HST	HEAT SHRINK TUBE WITH GLUE, BLACK	2
2	031 CABLE	22AWG COAXIAL+AL+MYLAR+BRAID, OD: 3.3mm, JACKET: PVC BLACK	A/R
1	FAKRA JACK(IP)	THERMOPLASTIC UL94V-0, 30u"AU	2
ITEM	PART	DESCRIPTION	Q'TY

UNLESS OTHERWISE SPECIFIED TOLERANCE		SIP		 CHANT SINCERE CO.,LTD
ANG.	±5°	Cmk Cpk		
0.	±0.50			
.0	±0.30	SCALE: AS SHOWN	UNIT: mm	TITLE: PDR-21054
.00	±0.20	DRAWN: CANDY_CHEN	19 Mar 2026	FAKRA JACK CABLE(IP RATING)
		CHECKED: VICKY_HSIEH	19 Mar 2026	PART NO. 1410102XXXX
		APPROVED: JASON_HUANG	20 Mar 2026	CODE: GC
		SIZE A4	SHEET 1/4	CUSTOMER:

G1, G9		Q	ECN-2602031(BENSON)MODIFY CODE & SEE PAGE 2/4, 3/4	11FEB2026
		P	ECN-2601025(CHICHI)SEE PAGE 2/4, 3/4	08JAN2026
		O	ECN-2512004(QUEENIE)SEE PAGE 2/4	01DEC2025
ZONE	REVISION	DESCRIPTION	DATE	
1	2	3	4	5

RoHS
compliant



LAST DIGITAL OF PART NUMBER X= CODING KEY , (EX. Z=Z/Z CODE)SEE PAGE 3/4

27	1410102029X	N/A	L1=400±15mm	COXOC LOGO	W/ LABEL
26	1410102028X	N/A	L2=1000±30mm	COXOC LOGO	W/ LABEL
25	1410102027X	N/A	L1=3100±50mm	COXOC LOGO	W/ LABEL
24	1410102026X	N/A	L2=500±15mm	N/A	W/O LABEL
23	1410102025X	N/A	L1=1000±30mm	N/A	W/O LABEL
22	1410102024X	N/A	L2=3000±50mm	N/A	W/ LABEL
21	1410102023X	N/A	L2=1900±30mm	N/A	W/ LABEL
20	1410102022X	CWS24ZZ3A02E12M	L1=12000±150mm	N/A	W/ LABEL
19	1410102021X	CWS24ZZ3A02E3M0	L1=3000±50mm	N/A	W/ LABEL
18	1410102020X	N/A	L1=13000±150mm	N/A	W/ LABEL
17	1410102019X	N/A	L1=8000±100mm	N/A	W/ LABEL
16	1410102018X	N/A	L1=2000±50mm	N/A	W/ LABEL
15	1410102017X	N/A	L2=1450±30mm	N/A	W/ LABEL
14	1410102016X	N/A	L1=15000±150mm	N/A	W/ LABEL
13	1410102015X	CWS24ZZ3A02E9M0	L1=9000±100mm	N/A	W/ LABEL
12	1410102014X	CWS24ZZ3A02E6M0	L1=6000±100mm	N/A	W/ LABEL
11	1410102013X	CWS24ZZ3A02E1M0	L1=1000±30mm	N/A	W/ LABEL
10	1410102012X	N/A	L1=10000±150mm	COXOC LOGO	W/ LABEL
9	1410102011X	N/A	L1=7000±100mm	COXOC LOGO	W/ LABEL
8	1410102010X	N/A	L1=5000±100mm	COXOC LOGO	W/ LABEL
7	1410102009X	N/A	L1=3000±50mm	COXOC LOGO	W/ LABEL
6	1410102008X	N/A	L1=300±15mm	N/A	W/ LABEL
5	1410102007X	N/A	L1=10000±150mm	N/A	W/ LABEL
4	1410102006X	N/A	L1=5000±100mm	N/A	W/ LABEL
3	1410102003X	CWS24ZZ3A02E1M8	L1=1800±30mm	N/A	W/ LABEL
2	1410102002X	CWS24ZZ3A02SE2M0	L1=2000±50mm	COXOC LOGO	W/ LABEL
1	1410102001X	CWS24ZZ3A02SE1M0	L1=1000±30mm	COXOC LOGO	W/ LABEL
ITEM	NEW P/N	OLD P/N	L (LENGTH)	LOGO	NOTE





UNLESS OTHERWISE SPECIFIED TOLERANCE ANG. ±5° 0. ±0.50 .0 ±0.30 .00 ±0.20	SIP Cmk Cpk	 CHANT SINCERE CO.,LTD
	SCALE: AS SHOWN	
DRAWN: CANDY_CHEN	19 Mar 2026	TITLE: PDR-21054
CHECKED: VICKY_HSIEH	19 Mar 2026	FAKRA JACK CABLE(IP RATING)
APPROVED: JASON_HUANG	20 Mar 2026	PART NO. 1410102XXXX
SIZE A4 SHEET 2/4	REV. Q	CODE: GC CUSTOMER:



C1	Q	ECN-2602031(BENSON)ADD PAGE & ADD P/N 1410102029X & SEE PAGE 1/4, 3/4	11FEB2026
C1	P	ECN-2601025(CHICHI)ADD P/N 1410102028X	08JAN2026
B1	O	ECN-2512004(QUEENIE)ADD NEW P/N(1410102027X)	01DEC2025
ZONE	REVISION	DESCRIPTION	DATE

RoHS
compliant

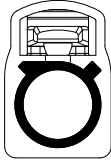
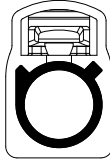
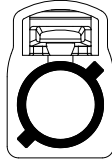
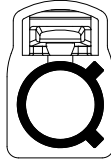
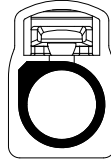

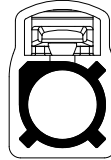
 FAKRA JACK
*=DEVELOPING

A	B	C	D	E	F	Z
JET BLACK SIMILAR RAL 9005	CREAM WHITE SIMILAR RAL 9001	SIGNAL BLUE SIMILAR RAL 5005	CLARET VIOLET SIMILAR RAL 4004	LEAF GREEN SIMILAR RAL 6002	NUT BROWN SIMILAR RAL 8011	WATER BLUE SIMILAR RAL 5021
						

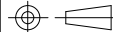
				UNLESS OTHERWISE SPECIFIED TOLERANCE ANG. ±5° 0. ±0.50 .0 ±0.30 .00 ±0.20		 SIP  Cmk Cpk		 CHANT SINCERE CO.,LTD	
				SCALE: AS SHOWN	UNIT: mm		TITLE: PDR-21054		
F1	Q	ECN-2602031(BENSON)MODIFY CODE & SEE PAGE 1/4, 2/4, 3/4		11FEB2026	DRAWN: CANDY_CHEN	19 Mar 2026		FAKRA JACK CABLE(IP RATING)	
	P	ECN-2601025(CHICHI)UPDATE & SEE PAGE 2/4		08JAN2026	CHECKED: VICKY_HSIEH	19 Mar 2026		PART NO. 1410102XXXX	
	O	ECN-2512004(QUEENIE)SEE PAGE 2/4		01DEC2025	APPROVED: JASON_HUANG	20 Mar 2026		CODE: GC CUSTOMER:	
ZONE	REVISION	DESCRIPTION		DATE	 SIZE A4	SHEET 2/3	REV. Q		

RoHS
compliant

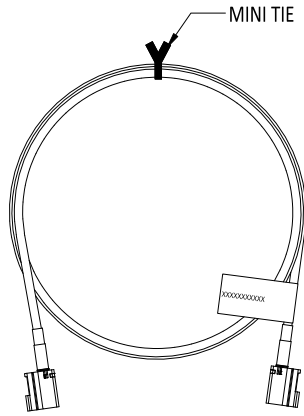

CABLE

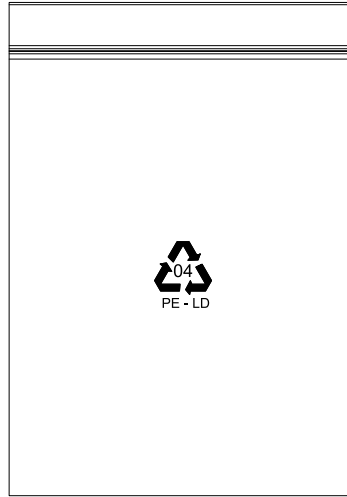

ZIP BAG

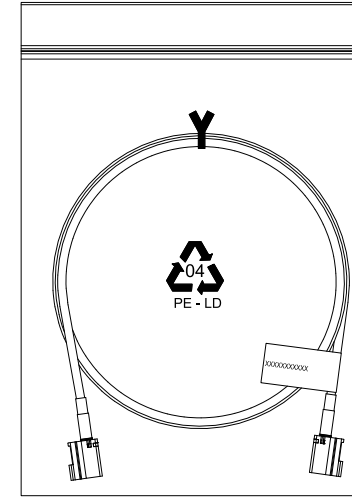

1PC/ZIP BAG

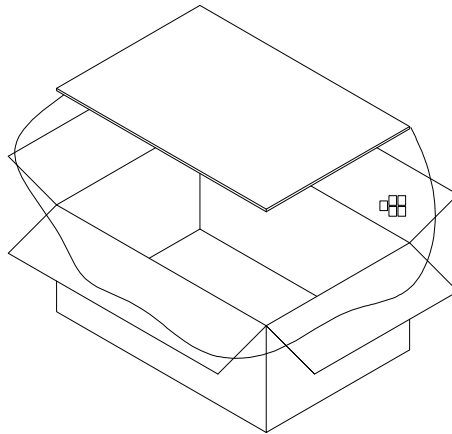

CARTON

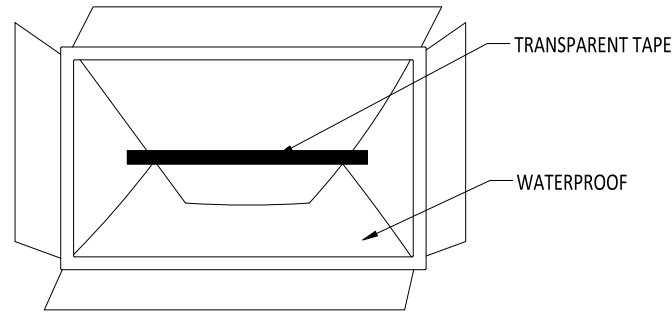

(AFTER THE INSTALLED PRODUCT,
CARTON SEALING TAPE SHOULD BE TRANSPARENT)

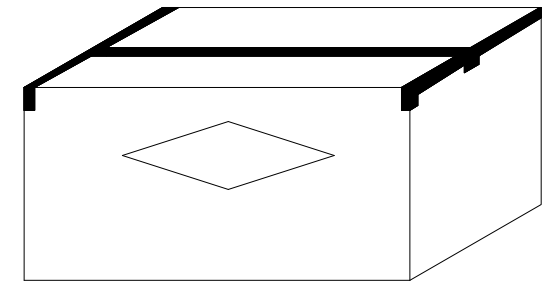

(THE PACKING QUANTITY IS BASED ON
THE FIRST BATCH OF ACTUAL ORDER)

5	DESICCANT	M90000EZ0000029	2g	5 PCS	
4	WATERPROOF	M9BE91461007009	914x610x0.07mm	1 PC	
3	CARDBOARD(B3B)	M9DE295450000500	295x450mm	2 PCS	
2	CARTON	M9CE451330229500	17.75"x13"x9"	1 PC	
1	ZIP BAG			1 PC/ZIP BAG	
ITEM	DESCRIPTION	PART NUMBER	SPECIFICATION	Q'TY	NOTE

UNLESS OTHERWISE SPECIFIED TOLERANCE		SIP		 CHANT SINCERE CO.,LTD
ANG.	±5°	ST Cmk Cpk		
0.	±0.50			
.0	±0.30			
.00	±0.20			
SCALE: AS SHOWN		UNIT: mm		
DRAWN: CANDY_CHEN		19 Mar 2026		TITLE: PDR-21054
CHECKED: VICKY_HSIEH		19 Mar 2026		FAKRA JACK CABLE(IP RATING)
APPROVED: JASON_HUANG		20 Mar 2026		PART NO. 1410102XXXX
SIZE A4 SHEET 3/3		REV. Q		CODE: GC CUSTOMER:

Q		ECN-2602031(BENSONI)SEE PAGE 1/4, 2/4, 3/4			11FEB2026
P		ECN-2601025(CHICHI)SEE PAGE 2/4, 3/4			08JAN2026
O		ECN-2512004(QUEENIE)SEE PAGE 2/4,			01DEC2025
ZONE	REVISION	DESCRIPTION			DATE
1	2	3	4	5	6